

EV[®] DYNACORD[®]

USER MANUAL

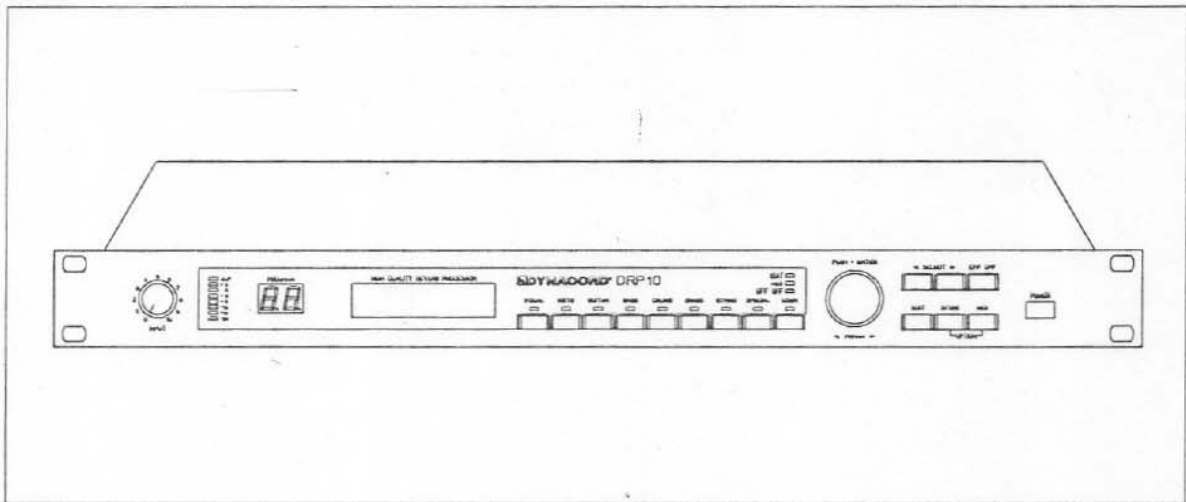

DRP 10

High Quality Reverb & Multi Effects Processor

TABLE OF CONTENTS

CHAPTER	CONTENT	PAGE
1.	INTRODUCTION	1-3
2.	PANEL DESCRIPTION AND CONNECTIONS	2-1
	2.1 Front Panel	2-1
	2.2 Rear Panel	2-3
3.	SETTING UP THE DRP 10	3-1
	3.1 Mono in/Mono out	3-1
	3.2 Mono in/Stereo out	3-1
	3.3 Stereo in/Stereo out	3-1
	3.4 Position of the Groundlift switch	3-1
4.	START-UP	
	4.1 Switching the unit on	4-1
	4.2 Level setting	4-1
5.	OPERATION	5-1
	5.1 Program selection	5-1
	5.2 Editing	5-2
	5.2.1 Selection of the effect structure	5-3
	5.2.2 Editing the parameters	5-3
	5.3 Saving and program title	5-5
	5.4 Copy	5-6
	5.5 Effect On/Off function	5-6
6.	EFFECT STRUCTURES	6-1
7.	EFFECTS AND PARAMETERS	7-1
	7.1 Effect/Parameter Table	7-1
	7.2 Description of parameters	7-2
	7.2.1 Direct signal path	7-2
	7.2.2 Equalizer	7-2
	7.2.3 Reverb	7-3
	7.2.4 Modulation	7-9
	7.2.5 Pitch Shift	7-12
	7.2.6 Delay	7-14
	7.2.7 Distortion	7-15
	7.2.8 Delay Line 1 > 2	7-16
8.	OPTION FUNCTIONS	8-1

9.	MIDI	9-1
	9.1. General description	9-1
	9.2. MIDI Main menu	9-2
	9.2.1 MIDI Receive channel	9-2
	9.2.2 MIDI Program table	9-2
	9.2.3 MIDI Dump	9-3
	9.2.4 MIDI IN Monitor	9-3
	9.3. MIDI Patch Menu	9-4
	9.4. MIDI Data format	9-6
10.	REMOTE CONTROL	10-1
	10.1 Remote connections	10-1
11.	APPENDIX	11-1
	11.1 How is reverberation produced	11-1
	11.2 What is MIDI	11-2
12.	SPECIFICATIONS	12-1
	12.1 Specifications	12-1
	12.2 MIDI Implementation chart	12-2
13.	SERVICE	13-1
	13.17 Block diagram	13-17
	13.23 Wiring diagram	13-23
	13.24 Dimensions	13-24
14.	WARRANTY	14-1

1. INTRODUCTION

First of all we should like to thank and congratulate you for choosing the Digital High Quality Reverb & Multi Effects Processor DRP 10 from DYNACORD.

The DRP 10 is a High Quality Stereo Reverb unit and room simulator with first rate single and multi effect features. Its new operator environment with Preset Group keys allow instant selection of effect programs from the instrument register.

All effects such as room reverb, plate reverb, delay, chorus, flanger, phaser, space, rotoflanging, pitch shift etc. can easily be changed in realtime and stored in 259 user memory places. The selection of various configurations enables the user to realize individual stereo effects and multi effects. Programms created by the user himself can be allocated to the instrument groups, to be called up quickly and easily by the appropriate selection key.

The DRP 10 can be used as a pre-switched unit, e.g. for guitars, or for looping into your mixing console. The inputs and outputs can be switched to -6 dBm or + 4dBm as required, allowing for straightforward adaptation of the DRP 10 to your existing equipment. The flat frequency response of 20 Hz to 20 kHz in the effect path ensures that the effects sound clear and transparent especially as regards the highs.

It goes without saying that the DRP 10 is equipped with a MIDI interface. MIDI can be used to change programms via remote control, to alter parameters dynamically, to edit parameters, transfer programs to other units and load them back to the DRP 10 again at any time.

This Owner's Manual is meant to help you familiarize yourself with all the DRP 10's other features. Please read it through carefully and we guarantee that your new DRP 10 High Quality Reverb & Multi Effects Processor DRP 10 from DYNACORD will give you great pleasure.

IMPORTANT NOTES

ATTENTION: This unit must be protected from damp because of fire risk and the possibility of electric shocks.

1. Make sure that nothing, especially no metal objects, are inserted into the device. This could result in a severe electric shock or malfunction.
2. If the unit is subjected to extreme fluctuations of temperature, e.g. on being transported from outside to a heated room, condensation can form. The unit should not be used until it has reached room temperature.
3. If water or any other liquid is spilt on to the unit accidentally, the unit should be switched off immediately and taken to a servicing facility to be checked.
4. Make sure that the unit is always well ventilated and never exposed to direct sunlight.
5. Do not use sprays to clean the unit as they have a detrimental effect on the unit and could ignite suddenly.
6. Inside the unit there is a battery to supply the RAM when the unit is switched off. This will ensure that your stored USER programs do not get lost. The service life of the battery is approx. 5 years. If the voltage drops below a minimum value, the following display appears after switching the unit on: "Service Required, Change Internal Battery". In this case contact the DYNACORD service center for changing the battery.

ON NO ACCOUNT SHOULD THE USER ATTEMPT TO DO THIS HIMSELF!

2. PANEL DESCRIPTION AND CONNECTIONS

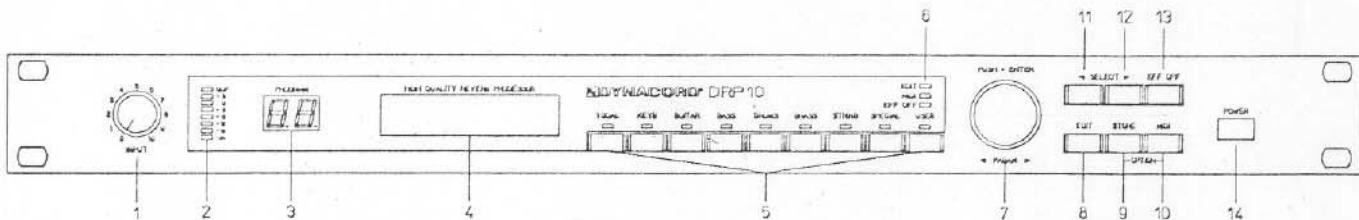

2.1 FRONT PANEL

1. INPUT control

This adjusts the input level of both channels in a range from -80 dB to +21 dB (if the INPUT selector on the rear side is in position LINE) or from -90 dB to +10 dB (INPUT selector in position INSTR).

2. Level indicator

This is for signal level monitoring, whereby the maximum value of the input or output level is always indicated. Another feature is the peak hold function which allows easy level matching.

3. Program number indication

This 2-digit display shows the number of the current program. The program number is related to the active effect group. During selection of a new program the indicator blinks until the program is activated by ENTER (= pressing of the rotary encoder).

4. Multi-functional display

This is a LC display involving 2 lines with 16 characters each. In PLAY mode the program name (upper line) and effect name (lower line) are indicated. In EDIT mode the parameter structure and a graphic and numeric parameter value are indicated. Depending on the current status OPTION menus, status messages, user guide messages etc. appear.

5. Effect group buttons

Activation of one of these keys provides access to the corresponding effect or instrument group in question (indication via LED), where the rotary encoder or SELECT keys are used for program selection. In each group there are 20 freely programmable program places (31-50). Furthermore, 99 programs can be stored in the user group. Press ENTER or activate a group key twice to activate the program selected.

6. Status/Mode LED's

These LED's indicate the DRP 10's current status. If the LED EDIT lights up, the EDIT mode is indicated. The LED MIDI lights up when MIDI parameters are being edited and on reception of MIDI data. The LED EFFECT OFF indicates that the effect unit has been switched off.

7. Rotary Encoder with ENTER button

In Play mode a program can be selected by turning the rotary encoder and activated by pushing the encoder (= ENTER). In Edit mode the parameter values can be altered by the rotary encoder. The input of the parameters can be accelerated by turning the encoder and keeping it pressed down at the same time. Generally speaking the rotary encoder serves for faster single-handed operation of the DRP 10.

For further information please see chapter "OPERATION", page 5-1.

8. EDIT Button

This button changes the operation to EDIT mode. After pressing this button, the first parameter of the active program is shown. Further parameters are accessible via the SELECT buttons. The value of the parameters shown can be changed via the rotary encoder.

For further information please see "EDITING", chapter 5.2.

9. STORE Button

With this button the edited programs can be stored in a user memory place in the selected effect group and the name of a program can be altered.

For further information please see chapter 5.3, "SAVING AND PROGRAM TITLE".

10. MIDI Button

This push-button calls up the MIDI editing mode. After pressing this button, global MIDI settings, program-related MIDI command sets, MIDI dumps etc. can be made. For more detailed information please see chapter "MIDI" on page 9-1.

9+10. OPTION Function

This button combination (STORE+MIDI pressed simultaneously) allows access to OPTION mode where unique settings for the unit can be made or checked.

For further information please see "OPTION", chapter 8.

11. SELECT < Button

In play mode this button selects the previous program number (activation by pushing the rotary encoder). In edit mode it is used for selecting parameters (always the previous parameter).

12. SELECT > Button

In play mode this button selects the next program number (activation by pushing the rotary encoder). In edit mode it is used for selecting parameters (always the next parameter).

13. EFFECT OFF Button

Pressing this button will switch off the effect unit and feeds the input signal without effect ("dry") to the output. The LED EFFECT OFF lights up. Pressing this button once more will switch on the effect again; the LED EFFECT OFF goes out. This function can be remote controlled by a foot switch (see rear panel). For further information please see "EFFECT ON/OFF FUNCTION", chapter 5.5.

14. POWER switch

This button is used to switch the DRP 10 on and off.

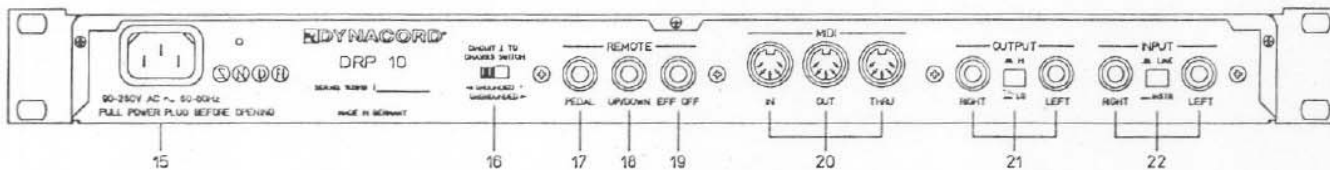

2.2 REAR PANEL

15. Mains socket

The DRP 10 is started up by connecting the enclosed mains cable to the mains socket. The DRP 10 is designed for mains voltages of 90 V to 250 V, meaning that fluctuations in mains voltage present no problem!

16. Groundlift switch

The groundlift switch serves to prevent hum loops. If the DRP 10 is operated together with other units in a 19" rack, the switch should be put on "GROUNDED". If the DRP 10 is used together with units which have different earthing potentials the switch should be put on "UNGROUNDED".

17. Remote socket PEDAL

An optional foot controller DYNACORD FR 5 can be connected here. This enables real time control of certain parameters. The control parameter for each DRP 10 program can be programmed separately.

For further information please see "REMOTE CONTROL", chapter 10.

18. Remote socket UP/DOWN

An optional foot switch DYNACORD FS 500 can be connected here to switch over programs. The user can determine which programmes are to be selected in the OPTION menu.

For further information please see "REMOTE CONTROL", chapter 10.

19. Remote socket EFFECT OFF

An optional foot switch DYNACORD FS 12 can be connected at this socket to switch the effect unit on or off (same function as EFFECT OFF on the front panel). Activating the foot switch for the first time switches the effect off, re-activation switches the effect back on again.

20. MIDI sockets IN/OUT/THRU

If the socket MIDI IN is connected with a MIDI-controlled unit, the DRP 10's programs can be selected from there. Parameter alterations are also possible, whereby the DRP 10 parameters can be assigned to the MIDI controllers at random. The MIDI OUT socket serves as a data output, e.g. to transfer the contents of the USER memory to a MIDI data recorder or another DRP 10. Data can thus be saved and re-loaded via MIDI IN at any time. All MIDI data received is passed on unchanged via the socket MIDI THRU.

For further information on MIDI please see chapter 9.

21. Sockets OUTPUT LEFT/RIGHT and level switch HI/LO

These are the DRP 10's stereo outputs. A level switch can be used to select a nominal output level of +10 dBu (HI) or 0 dBu (LO). If only one of the two jack sockets is used, this results in a MONO sum from the left and the right channel.

22. Sockets INPUT LEFT/RIGHT and selection switch LINE/INSTRUMENT

These are the DRP 10's stereo inputs. The selection switch can be used to choose between LINE input (+4 dBu) or Instrumental input (-6 dBu, high-Z). In order to feed in a MONO signal simply connect just one of the two input sockets.

3. SETTING UP THE DRP 10

To achieve the best results with the DRP 10, the unit must be connected properly. To start the unit up connect the enclosed mains connection cable with the DRP 10's mains socket and your power supply.

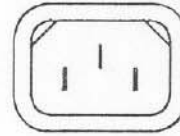

3.1 Mono in / Mono out

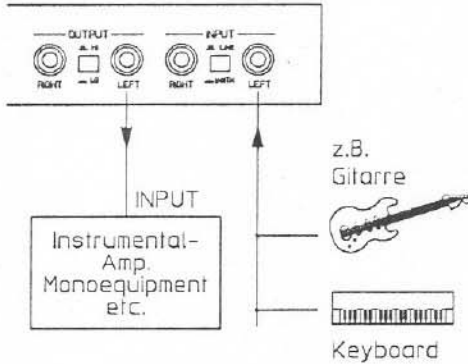

3.2 Mono in / Stereo out

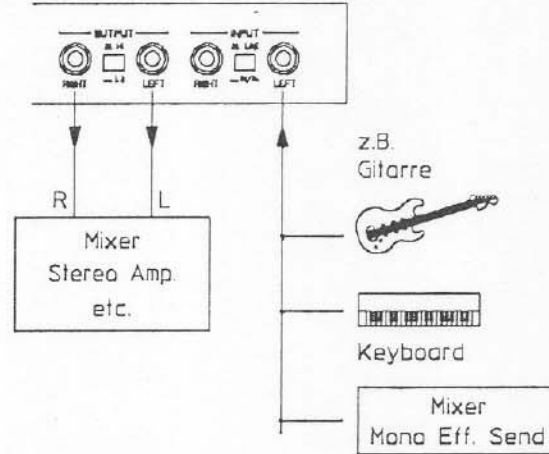

3.3 Stereo in / Stereo out

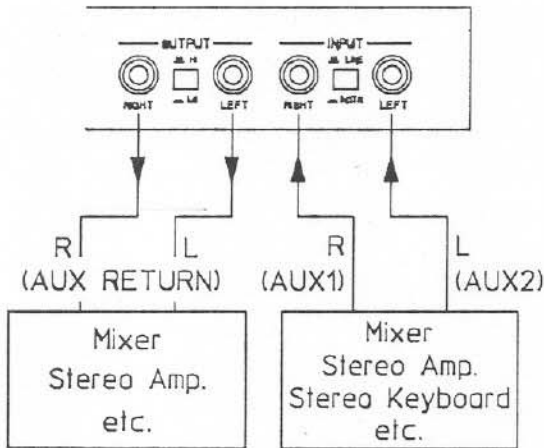

Important:

- Always use well-screened audio cables.
- To avoid high frequency losses the feeding lines, especially to the inputs, should not be longer than 10 m.
- Do not position the unit directly on or under a powerful power amplifier, TV monitor or the like, as the leakage field of the transformers in such devices could induce hum in the electronics of the DRP 10.

3.4 Position of the Groundlift switch

The groundlift switch serves to avoid hum loops. Dependent on the operational condition it should be switched into following positions:

UNGROUND: If you use the DRP 10 together with units with different earthing potentials.

GROUND: If you use the DRP 10 together with other units in a 19" rack.

CIRCUIT 1 TO CHASSIS SWITCH



◀ GROUNDED
UNGROUND ▶

4. START-UP

4.1 SWITCHING THE UNIT ON

1. The DRP 10 is switched ON via the POWER switch (14).
2. The following appears on the display:
3. Subsequently the DRP 10 is ready for operation and is in Play mode. The following may appear on the display:

POWER



01

DYNACORD DRP 10
Effect Processor

01

Vocal Pepper
(H Q Reverb)

01

Service Required
Chng. Int. Battery

NOTE!

If the display on the right side appears after the unit has been switched on, you should contact the service center to change the internal battery.

In this case the battery voltage has dropped below a min. value and there is no guarantee as to whether your program data will be maintained in the memory after disconnecting the unit from the mains supply.

4.2 LEVEL SETTING

1. First set the INPUT selector switch depending on which equipment has been connected.
2. While the level is being adjusted via the INPUT control (1), keep checking the maximum indication on the level meter (2). The optimum value is 0 dB. If the control range should prove insufficient, press the INPUT selector switch (at the rear) to INSTR. The CLIP LED indicates internal overdriving and should on no account be lit up.

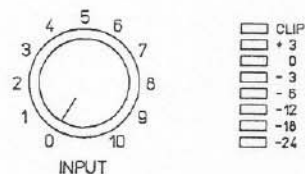

INSTR: This range is selected for low levels, such as electric guitar or bass. The inputs are Hi-Z.

LINE: This range is selected for medium to high levels, e.g. AUX- OUTPUT, audio equipment with line level, drum computers etc.

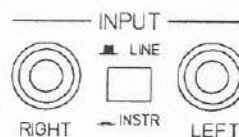

5. OPERATION

The DRP 10 is operated via an rotary encoder with a push function (ENTER) and 6 function keys and 9 effect group keys.

The DRP 10 contains 5 different modes which can be selected directly from any state.

1. PLAY MODE:

Mode after switching on
Program selection mode
Activation with effect group keys

2. EDIT MODE:

Effect parameters are edited here.
Indication via EDIT LED
Activation via EDIT key

3. STORE MODE:

Storing and copying programs
Title editing
Activation via STORE key

4. MIDI MODE:

Setting of global MIDI parameters and program specific MIDI Parameters
Indication via MIDI LED
Activation via MIDI key

5. OPTION MODE:

Editing functions pertaining to equipment
Activation via OPTION keys

5.1 PROGRAM SELECTION

Programs can only be selected when the DRP 10 is in Play mode. This is the case after switching on, for example.

The DRP 10 contains 240 fixed factory programs

01 - 30 (per effect group)

and in addition, 259 freely programmable User programs

31 - 50 (per effect group)

01 - 99 (USER group)



- 1 To call up a memory place you press one of the effect group keys (5) in order to select the effect or instrument group required.
(Not necessary if you are already in the program level required)

2 Either look for the required program with the **Rotary Encoder (7)** or with the two **SELECT keys (11)** and **(12)**.

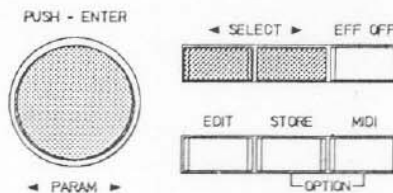

3 The program name selected appears on the display and the program number and the effect group LED blink.

05

Chorus Voice
(H Q Modulation)

4 Activate the program by pressing the **Rotary Encoder (ENTER) (7)** (= ENTER).

The Rotary Encoder is a fine detent control without left or right limit stop and with an integrated key. It works like an electronic step counter which counts one detent every time it is activated. If keeping pushed during rotation, 10 units per detent are counted.

In the Play mode it is used to select a memory place, otherwise it is used to perform all value inputs.

Pressing the rotary encoder (= ENTER) confirms all inputs.

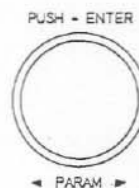

For information on program selection via remote control please see chapter "REMOTE CONTROL", page 10-1.

IMPORTANT

- Hectic and powerful rotating the encoder does not accelerate the input process but possibly damages the detent mechanic.

5.2 EDITING

The DRP 10 has a large number of editing possibilities, meaning that the user is free to create completely individual effect programs.

Before you actual start with editing effect parameters, select a program with the effect structure (configuration) in question, described in 5.2.1. Then you can change one or more parameters within the program (5.2.2).

IMPORTANT:

- While editing, use the table on page 7-1. This is an important editing aid and tells the user:
 - 1 Which and how many parameters are in each effect structure.
 - 2 The value range of each parameter.

5.2.1 SELECTION OF THE EFFECT STRUCTURE

The effect structure is the skeleton of every program. It determines which individual effects are to take part. The name of the effect structure is shown in the lower line of the display. For a description of all effect structures please turn to chapter 6.

- 1 To locate a program with the desired effect structure within any effect group, use the rotary encoder (7) or the two SELECT keys (11) and (12), as described under "PROGRAM SELECTION".
- 2 The selected effect structure is shown on the display with its program title, e.g.:
- 3 Activate the program by pressing the rotary encoder (7) (=ENTER).

The desired effect structure is thus activated. You can now edit any parameter, change the name of the program and store the result in a USER memory location within any effect group as required.

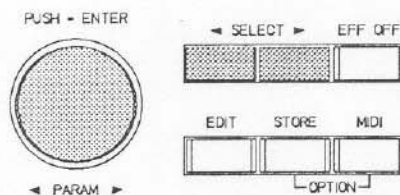

07

Austrian Joy
(Delay + Reverb)

5.2.2 EDITING THE PARAMETERS

Parameters are altered in EDIT mode. For a description of all parameters please turn to chapter 7.

- 1 Press the EDIT key (8).
- 2 You are now in EDIT mode. The EDIT LED lights up and the name and the value of the first parameter in the active program appear on the display. A graphic indication of the parameter value gives constant information as to one's current position in the parameter range.

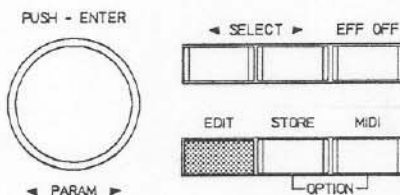

01

REVERB LEVEL
■■■ - 25 dB

- 3 The rotary encoder (7) can now be used to alter the parameter value. If the rotary control is kept pressed while turning, the parameter input is accelerated. (greater step width).

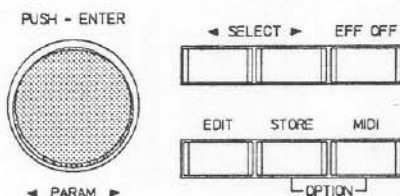

4 The set value appears on the display and the change is immediately audible. The EDIT LED then blinks to show that the program has been changed. If you do not wish to alter further parameters, proceed directly to point 7.

5 The SELECT keys (11) and (12) take the user directly to the next parameter. The EDIT key (8) takes the user to the next individual effect in the structure.

Note:

- By repeated pushing of the EDIT key you switch to the next single effect in the active configuration. For the order please see description of the effect structures in chapter 6.

6 The following may appear on the display:

Points 3 to 6 can be repeated as often as required.

7 Pressing the active effect group key takes the user back to Play mode.

NOTE! Your program alterations have not yet been stored and will be lost at the next program change!

8 The program name appears again on the display. The EDIT LED continues to blink. There are several different possible ways of continuing:

- if you should wish to give the program a new name, proceed directly to chapter 5.3.
- if you should wish to store the edited program in a memory place, proceed to chapter 5.4.
- if you should wish to continue to alter parameters, start again at step 1.
- if you should require the original program again, press the rotary encoder (ENTER). The altered parameter values are thus deleted. The EDIT LED goes off.

Note:

- You can switch to store mode directly by pressing the key STORE (9) in edit mode!

01

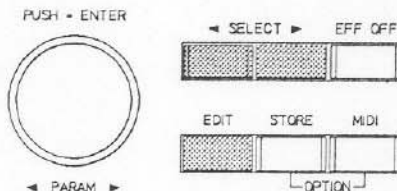
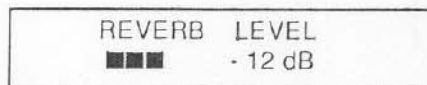

01

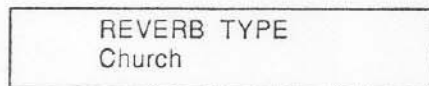

F 01

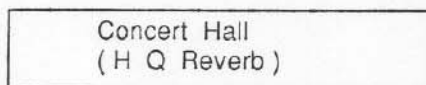

5.3 SAVING AND PROGRAM TITLE

No matter whether you are editing a program (parameter) or wish to save the alteration of a name, the saving procedure is always the same. The same applies to saving MIDI patches. All values are stored under the desired user program place in the selected effect group. The storing procedure is initiated and ended via the STORE key (9) on principle. You can prevent storing by cancelling the procedure with any MODE key, (EDIT, MIDI, OPTION) or one of the effect group keys.

- 1 Press STORE (9) to initiate the storage procedure.

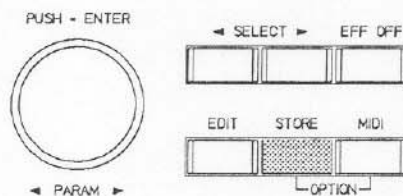

The following may appear on the display:

35

STORE to VOCL 35
Studio Classic

- 2 If you wish to save the program in the place suggested by the DRP 10, without altering the name, proceed directly to step 7. If you only wish to alter the name but not the program place, proceed to step 5.

- 3 With the SELECT < key (11) you can put the cursor on the effect group name and select then the desired effect group with the rotary encoder (7).

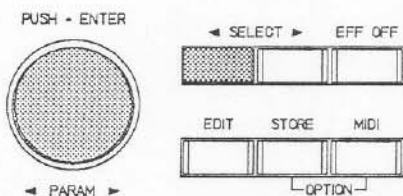

- 4 Put the Cursor again on the program number with the SELECT > key (12) and select the desired memory place via the rotary encoder (7). You can continue with step 7 if the name is not to be altered.

- 5 Select the title line (2nd line) via the SELECT keys (11) and (12).

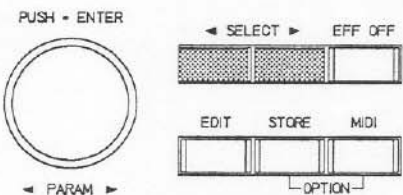

- 6 The desired characters can be set on the blinking cursor position via the rotary encoder (7). For a space or to delete a character press the rotary encoder (7). The SELECT keys (11) and (12) can be used to move the cursor backwards and forwards and to move back to the 1st line.

- 7 Final storage occurs by pressing the key STORE (9) again. NOTE! The previous program occupying that particular memory place will be deleted! Therefore make sure that the destination program number corresponds with the number you require. The storage procedure can be cancelled by pressing any MODE key at random.

35

STORE to KEYB 31
Homerecord 1

The following may appear on the display:
The new program is activated.

31

Homerecord 1
(H Q Reverb)

5.4 COPY

In the DRP 10 it is possible to copy programs from one memory place to any other.

The procedure is similar to that of storing a program.

- 1 In Play mode select the program you wish to copy (see program selection 5.1)
- 2 Press the key STORE (9) to initiate the copying procedure.

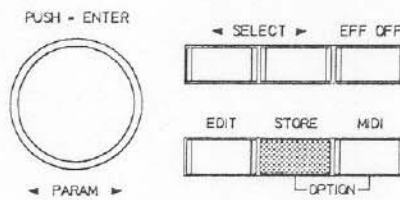

The following may appear on the display:

- 3 Select the effect group and the memory place where you wish to copy your program.
- 4 Storing occurs when the STORE key (9) is pressed again.

The copy procedure can be cancelled by pressing any other MODE key at random.

- 5 "Program stored" appears on the display (for approximately 1 second) once storage has been completed.
- 6 Then the DRP 10 returns to Play mode. The copied program is active in the new memory place.

02

STORE to VOCL 31
Cathedral

02

Program
stored ...

31

Cathedral
(H Q Reverb)

5.5 EFFECT-ON/OFF FUNCTION

To switch the effect signal off, activate the EFF OFF key (13). You then hear the direct signal without effect (dry).

The appropriate LED signalizes this state to the user.

Press the key EFF OFF (13) again to switch the effect back on. The EFF OFF LED goes off and the effect is applied to the signal again.

Informations for remote control of these functions please see page 10-1, "REMOTE CONNECTIONS".

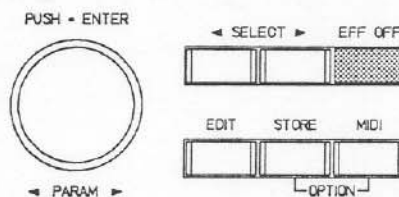

IMPORTANT!

- The direct signal remains unchanged during the EFF ON/OFF function but it only appears at the output when the ORIGINAL LEVEL of this program is turned on.

6. EFFECT STRUCTURES

The DRP 10 has 10 different effect structures (configurations). These provide the basis for drawing up a program. Each effect structure consists of various individual effects and the corresponding parameters. The selection and number of parameters is ideally suited for creating the effect in question.

For a description of the individual parameters please turn to chapter 7. The effect/parameter table in chapter 7.1 shows which individual effects and parameters are available in which effect structure.

All the effect structures are listed and explained in more detail in this chapter.

A Direct only

B High Quality Reverb

C High Quality Modulation

D Pitch Shift

E Long Delay

F Delay + Reverb

G Pitch + Delay + Reverb

H Modulation + Delay + Reverb

I Distortion + Modulation + Delay + Reverb

K Delay Line 1 > 2

A DIRECT ONLY

This structure merely serves to loop an input signal through to the output directly. The output volume can be stored at the same time. This type of program serves to provide dynamic volume control via MIDI commands - (see MIDI).

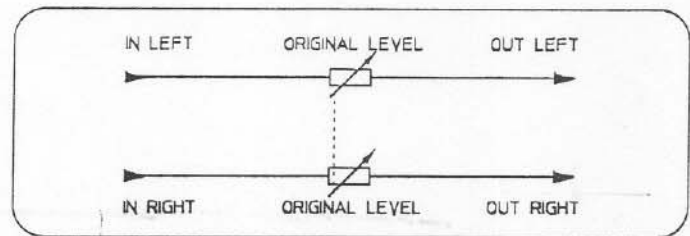

B HIGH QUALITY REVERB

This structure serves to simulate stereophone room images. It is thus possible to generate an unusual variety of different types of reverberation. A subsequent EQ section can be used to control the basses and trebles of the reverb signal.

The total capacity of the DRP 10's effect chip is available for reverb creation, allowing for the very best reverb quality with this particular structure. There is a choice of nine different types of reverb, whereby the type "All parameters" comprises 11 reverb parameters. This can be used to provide any conceivable type of reverb characteristics.

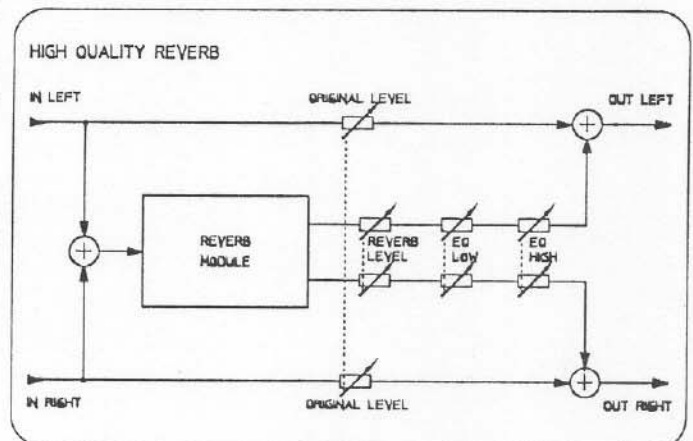

C HIGH QUALITY MODULATION

In this effect structure a number of delays work with their own, independent modulators to draw up any conceivable chorus, flanging, phasing and rotor effects.

Here too, the DRP 10's total computer capacity is on hand, making for particularly "warm" and "rich" modulation sounds.

The subsequent EQ section also enables the user to set the modulated signal's basses and trebles as required.

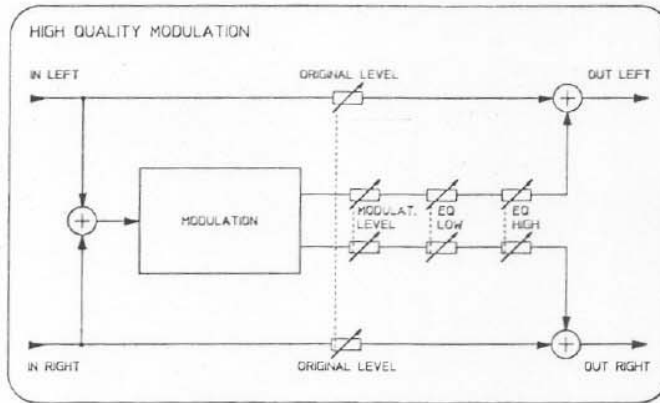

D PITCH SHIFT

This effect can be used to add two effect signals to the signal, which have a shifted pitch compared with the direct signal.

In this way, whole chords can be produced with e.g. one note.

The subsequent EQ section can also be used in this configuration to control the effect signal's basses and trebles as required.

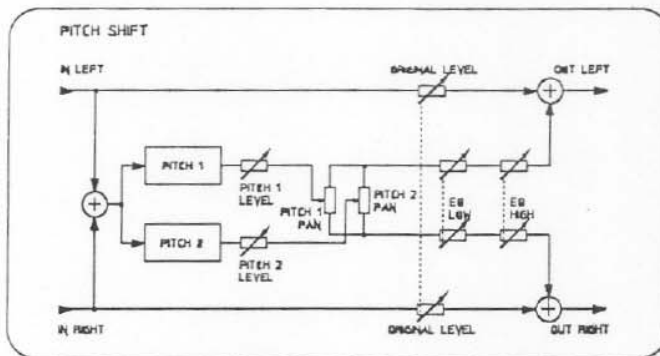

E LONG DELAY

This structure provides a delay line with feedback and a subsequent EQ section. This can be used to create delays with long repeat intervals (to over 1 second). The effect signal's basses and trebles can be set as required.

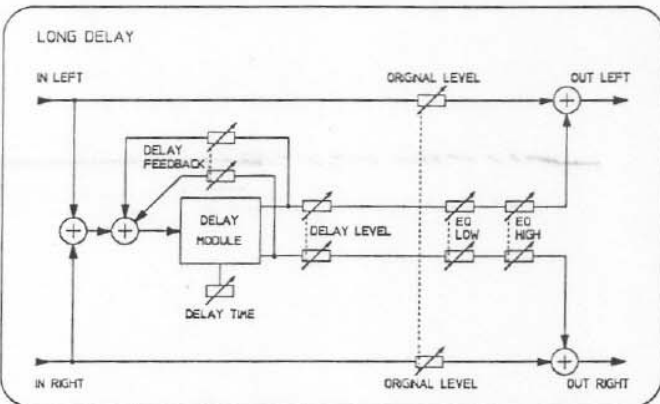

F DELAY + REVERB

A delay module and a reverb module are switched parallel in this structure.

As the reverb module is within the delay feedback, this produces a special type of delay effect with reverb which particularly enhances live performances.

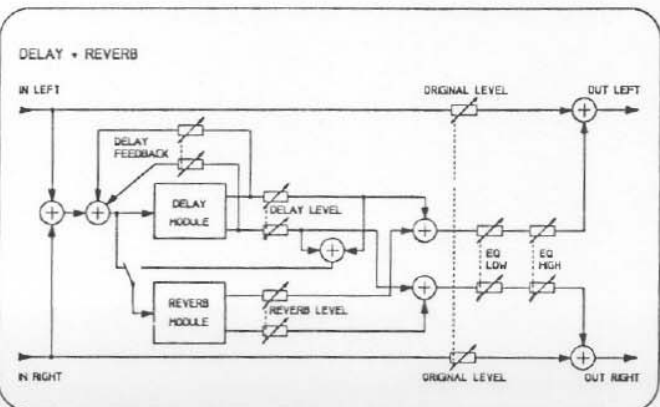

G PITCH + DELAY + REVERB

This consists of a reverb structure and a delay and a pitch shift combined. The transposed signal and the direct signal can be processed in the subsequent REVERB MODULE in order to create a feeling of space. Additionally a delay effect can be mixed in.

Here, too, basses and trebles can be controlled via a subsequent EQ section.

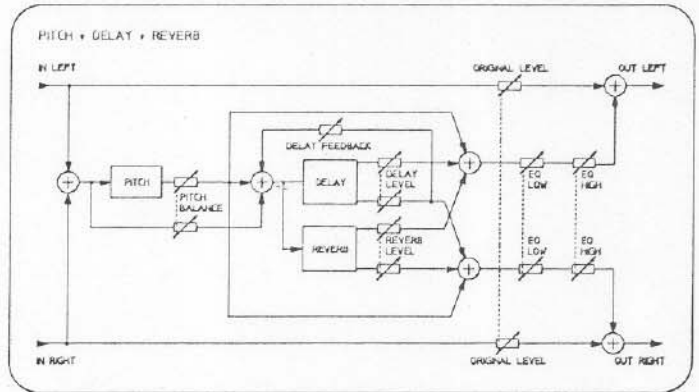

H MODULATION + DELAY + REVERB

This effect consists of four individual effects. These include Modulation, Delay, Reverb and Equalizer. Here, too, there is a wide variety of editing possibilities, as already described previously.

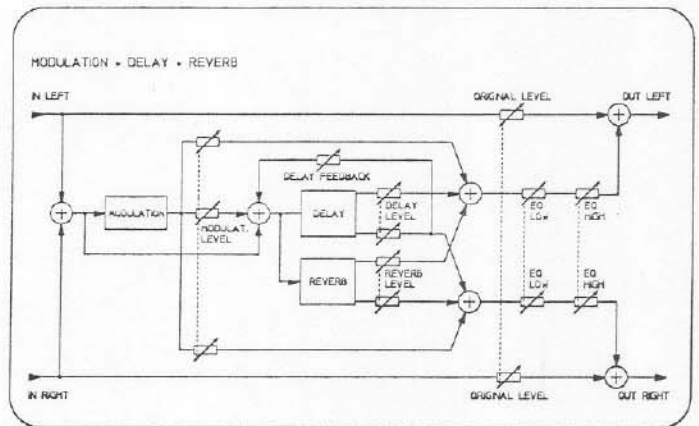

I DISTORTION + MODULATION + DELAY + REVERB

This effect is mainly of interest when it comes to guitars and basses. It consists of six different individual effects, namely Distortion, Voice Filter, Modulation, Delay, Reverb and Equalizer. There is also a wide choice of effect editing possibilities in this structure.

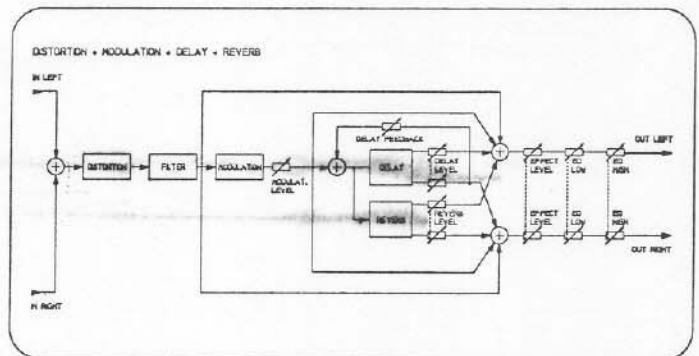

K DELAY LINE 1 > 2

This is a delay line with one input and two outputs. A maximum delay time of 1 second is to be set for the two outputs. In the signal path there is also an EQ section which enables the user to control basses and trebles as required.

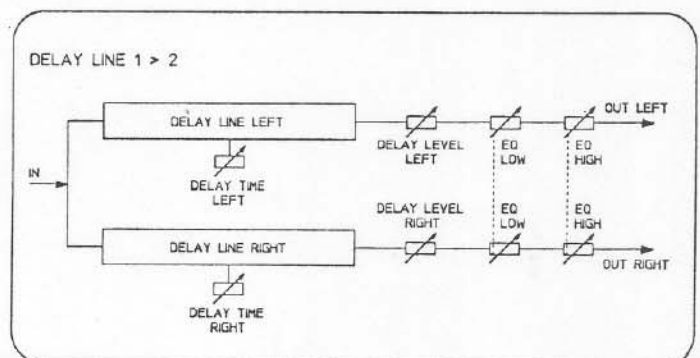

7.2 DESCRIPTION OF THE PARAMETERS

Different manufacturers often give the same function different names. In order to avoid confusion and to give the user more details about the parameters' tasks and settings, this chapter contains a description thereof.

7.2.1 ORIGINAL SIGNAL PATH

The DRP 10 contains an direct signal path in stereo. This is required when the DRP 10 is used as a pre-switched unit. A parameter is available for this signal path:

ORIGINAL LEVEL

This is used to set the volume of the direct signal for both the left and the right channel.

Valuation range: 0dB - -79dB, -OFF-

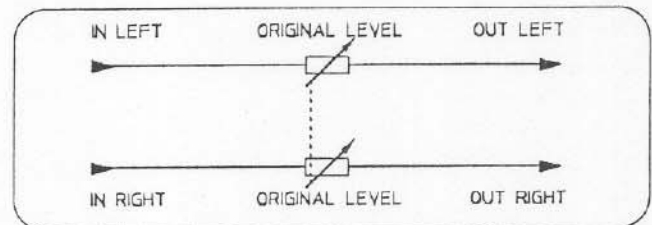

01

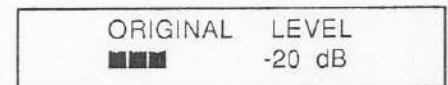

Important

- If the direct signal is not audible and if -OFF- appears on the display instead of dB values, the DRP 10 is switched to "Original OFF" in OPTIONS Mode. Switching over to "Original ON" makes the direct signal appear at the output at the volume programmed originally. (see "OPTION", Chapter 8)

7.2.2 EQUALIZER

The DRP 10's effect path is equipped with a 2-band EQ for tone control of the effect signal. The basses and trebles can be raised or lowered by a maximum of 14 dB. The equalizer has two parameters:

EQ LOW

Raising or lowering the basses is set with this parameter. The corresponding filter has low-shelving characteristics.

Valuation range: -14dB - +14dB

EQ HIGH

Raising or lowering the trebles is set with this parameter. The filter has high-shelving characteristics.

Valuation range: -14dB - +14dB

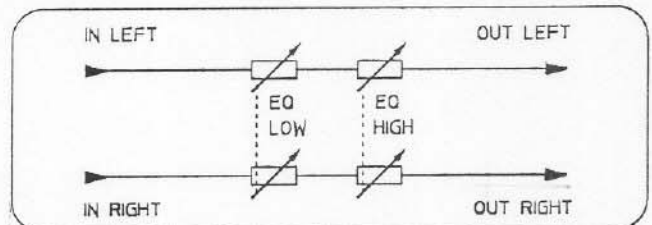

27

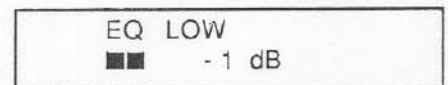

27

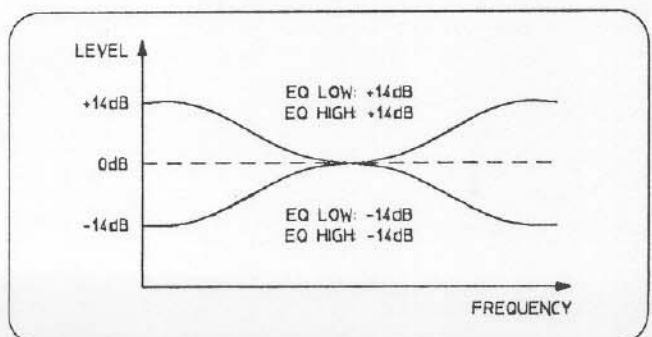
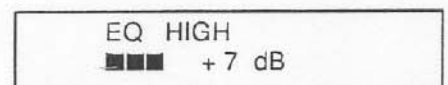

7.2.3 REVERB

The reverberation is the most complex of the effects produced by the DRP 10. It consists of a variety of parameters which are described below.

Depending on the type of reverb selected, different parameters appear. The diagrams below illustrate which parameters are available for which type of reverb.

If you should still be relatively unfamiliar with effect units and the creation of reverberation, read this chapter through carefully, along with the Appendix 11.1 "How is reverberation produced", before editing a program.

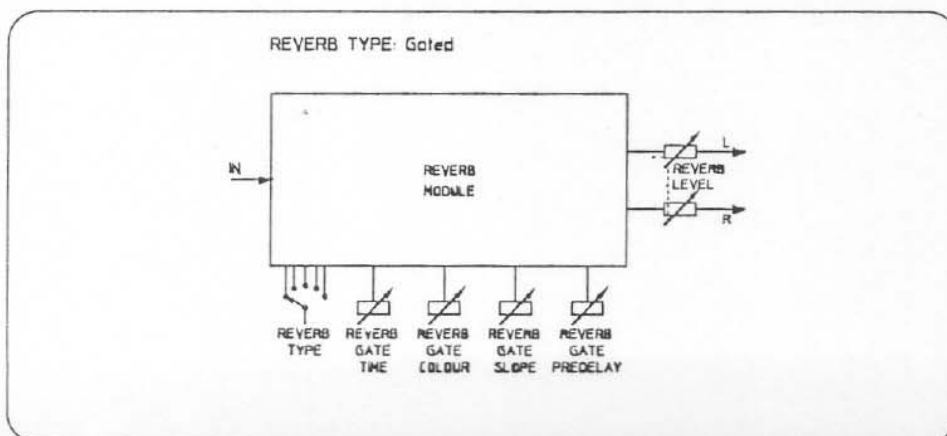
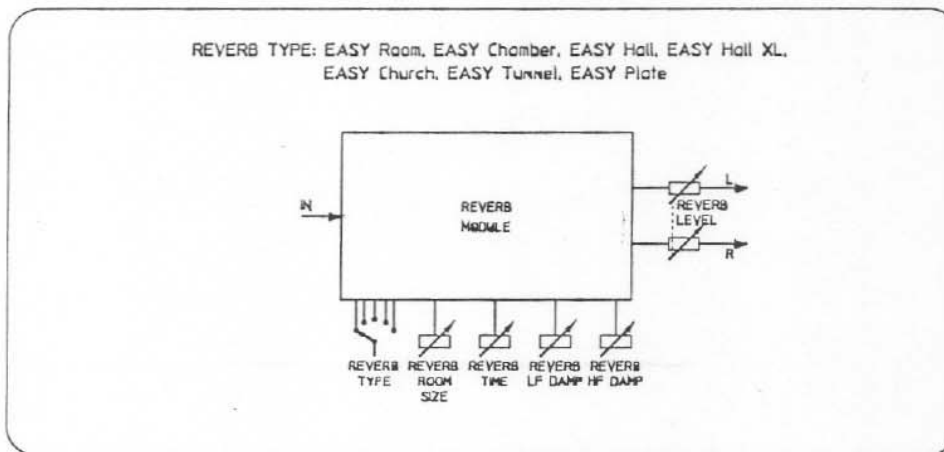
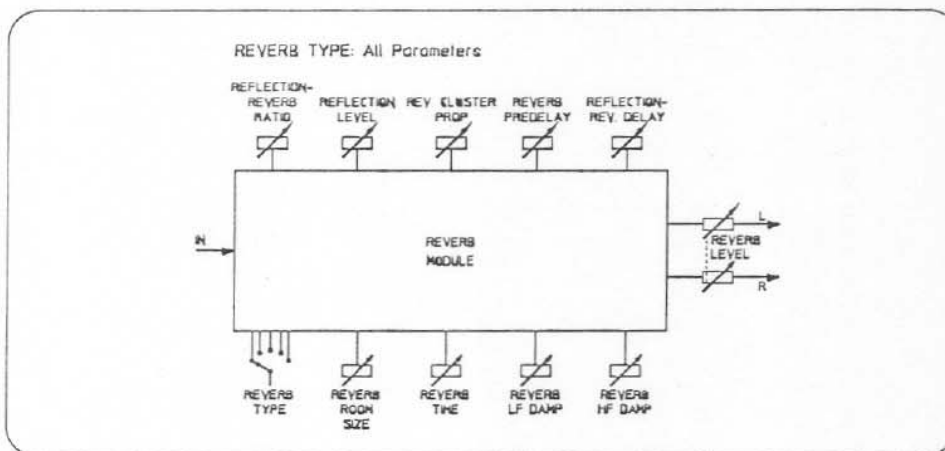

REVERB LEVEL

This parameter determines the volume of the reverb. The reading appears in dB.

Valuation range: 00 dB - - 48 dB, -OFF-

01

REVERB LEVEL
■■■■ - 12 dB

REVERB TYPE

The type of reverb is determined by this parameter. Depending on the geometry of the room or the propagation medium, there are differing reverb characteristics which can be selected here.

01

REVERB TYPE
EASY Room

Settings: All parameters
EASY Room
EASY Chamber
EASY Hall
EASY Hall XL
EASY Church
EASY Tunnel
EASY Plate
Gated

The following parameters depend on the "REVERB TYPE" set. "All Parameters" means that the user has access to all reverb parameters. If you want a quick result, simply select one of the EASY types. These provide fewer parameters, but the complexity of the reverb remains the same. Depending on the type of reverb, a number of optimum internal parameters are pre-set.

REVERB ROOM SIZE

This is used to set the size of the room. The readings appear in cubic metres.

Valuation range: 0.0 cbm - 124 990 cbm

01

REVERB ROOM SIZE
■■■■■ 91120 cbm

REVERB TIME

The duration of the reverberation is the time which elapses until the reverberation has faded to one thousandth (-60 dB) of the initial level. Reverb Time can be used to set the duration of the reverb. Reverb Time is a feedback factor similar to feedback with delays. The reading appears in seconds.

Valuation range: 0.0 s - 19.9 s.

01

REVERB TIME
■■■ 2.4 s

REVERB LF DAMP

This parameter is very important for the characteristics of various rooms together with HF Damp. They are responsible for the reverb's frequency response.

REVERB LF DAMP determines the damping of the basses in relation to the reverb time.

The reverb time multiplied by the Damp value set gives the reverb time of the basses.

e.g. REVERB LF DAMP: 0.5 --> 8s x 0.5 = 4s

In this case the basses would already have faded after half of the normal reverb time.

Valuation range: 0.0 - 1.1

01

REVERB LF DAMP
■ x 0.5

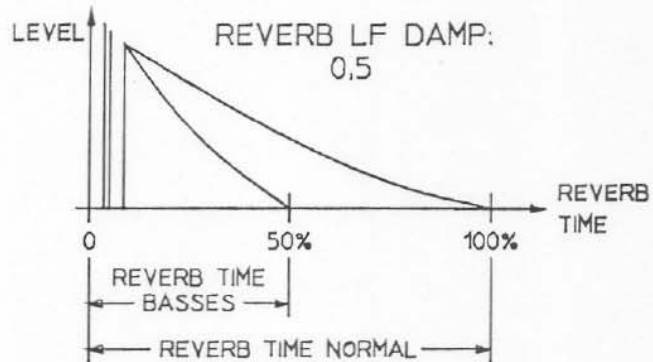

REVERB HF DAMP

Together with LF Damp this parameter is of great importance for the characteristics of various rooms. They are responsible for the frequency response of the reverberation.

REVERB HF DAMP determines the damping of the trebles in relation to the reverb time.

The reverb time multiplied by the set Damp value gives the reverb time of the trebles.

e.g. REVERB HF DAMP: 0.5 --> 8s x 0.5 = 4s

In this case, the trebles would already have faded after half of the normal reverb time.

In practice, this would correspond with a vaulted cellar with rough walls, for example. The trebles die down quickly, while the basses take longer to fade.

This would not apply in an empty, tiled room where trebles and basses fade at the same time (LF = 1.0, HF = 1.0).

Valuation range: 0.0 - 1.0

01

REVERB HF DAMP
■ x 0.5

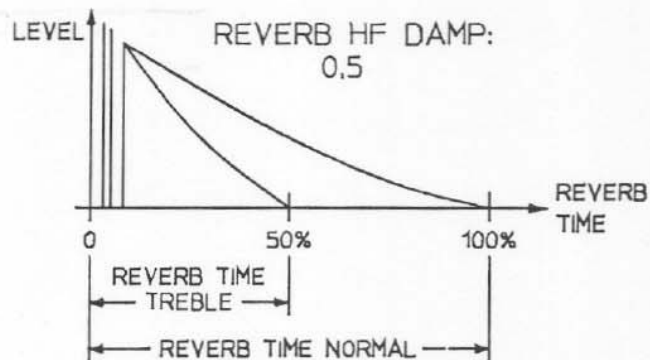

REFLECTION - REVERB RATIO

This parameter determines the level relationship between the first reflections and the real reverb proportion.

Valuation range: Revb. only
-48dB - +48dB
Refl. only

First reflections and reverb clusters can be mixed at random or, in extreme cases, can be switched off altogether.

In practice, "soft" rooms (negative dB values) and "hard" rooms (positive dB values) can be realized.

01

REFL-REV RATIO
■■■■ + 28 dB

REFLECTION TYPE

These parameters are used to determine the type of the first reflections. There are 10 different clusters to choose from.

Settings: Room
Chamber
Hall 1
Hall 2
Hall 3
Plate
Spring
Reverse
Left > Right
Expand

01

REFLECTION TYPE
Hall 1

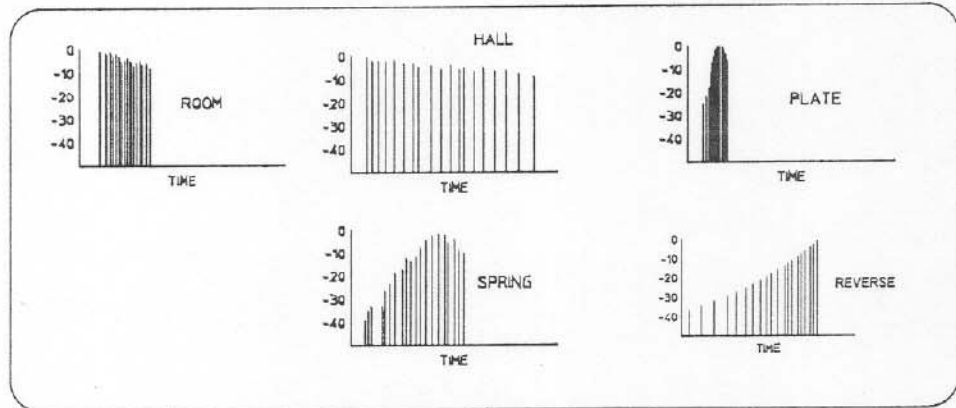

With the setting "Left > Right" the first reflections in the stereo image move from left to right, and with "Expand", to the left or the right, starting from the middle.

REVERB CLUSTER PROPORTION

Determines the geometrical features of a room or reverb medium. There are 6 proportions to choose from.

1. **CATHEDRAL** - Acoustically speaking, a very favourable, block- shaped room (e.g. church, cathedral)
2. **CAVE** - A flat, relatively low room (e.g. subterranean garage, cellar...)
3. **CUBE** - An even, cube-shaped room (e.g. a small, but high room, a high warehouse...)
4. **TUBE** - A long, almost cylindrical room, (e.g. subway, tunnel, bunker, wine cellar...)
5. **PLATE** - Simulates the effect of a reverb plate (quick transient response)
6. **ROOM + PLATE** - A combination program consisting of reverb plate and room reverberation.

01

REVERBLAT PROP
Cave

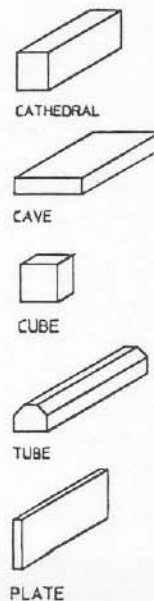

REVERB PREDELAY

The Predelay parameter sets the time between the direct signal and the begin of the real reverberation. The reading appears in ms.

Valuation range: 0 ms - 240 ms

In practice, this parameter gives the size of a room and the distance of the sound source from the walls.

01

REVERB PREDELAY
■ 50 ms

REFLECTION REVERB DELAY

This parameter serves to determine the time between the first reflections and the reverberation. The readings appear in ms.

Valuation range: 0 ms - 100 ms

If the parameter is set at 0 ms, the reverb starts at the same time as the first reflections. First reflections and reverb thus mingle.

01

REFL - REV - DELAY
■ 25 ms

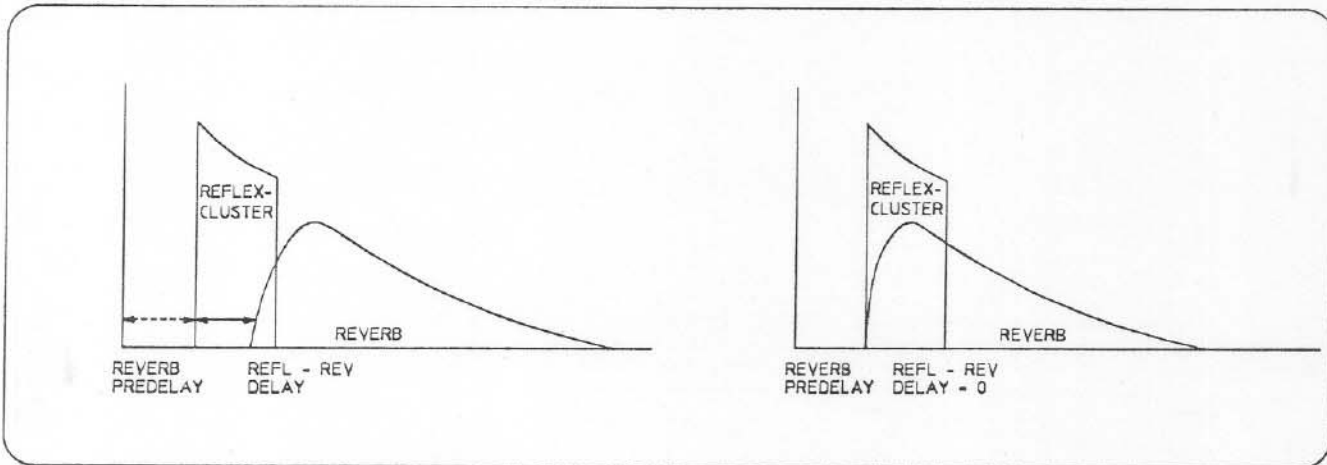

REVERB GATE TIME

This parameter only appears if the REVERB TYPE "Gated" has been selected. It indicates the opening time of the gate in milliseconds.

Valuation range: 10 ms - 340 ms.

01

REVB GATE TIME
■■■ 260 ms

REVERB GATE COLOUR

This parameter is used to select the "colour" of the Gated Reverb.

The larger the set value, the more dense is the sequence of the individual reflections.

The readings appear in relative values.

Valuation range: 1 - 10

01

REVB GATE COLOR
■ 6

REVERB GATE SLOPE

This is also a parameter which only appears in connection with "Gated". The switching off characteristics or the decay of the Gate is determined by Slope according to the Gate Time set.

Valuation range: -10 - 10

- 10 = Reverse

0 =

10 = Normal



01

REVB GATE SLOPE
■■■ 5

REVERB GATE PREDELAY

This determines the time between the direct signal and the beginning of the reverb in "Gated Reverb". The readings appear in ms.

Valuation range: 0 ms - 200 ms

01

REVB GATE PREDLY
■ 50 ms

7.2.4 MODULATION

The modulation section comprises effects such as Chorus, Flanger, Phaser, Rotor etc. A number of delay lines are controlled by independent modulators to make the direct sound "broader" and "warmer", or to produce unusual, artificial colourations.

The varying types of modulation are described as follows:

CHORUS:

The Chorus effect is basically a modulated delay. The delayed signal is modulated via an LFO, whereby the necessary delay time lies between 10 and 30 ms. In the DRP 10, there is a chorus with up to 6 independent "voices" which can each be modulated differently. The result is a "multiplication" of the sound fed in.

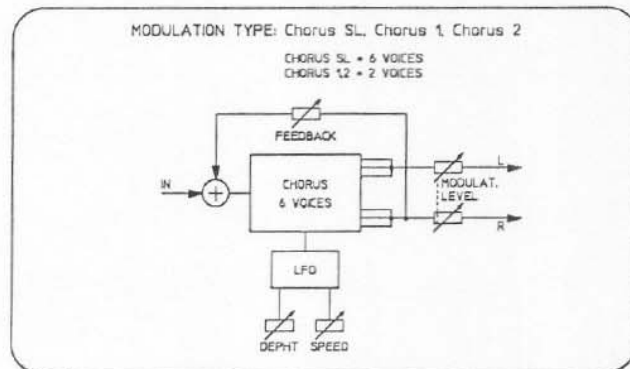

FLANGER:

The flanging effect is also based on a mixture between delayed and non-delayed signals. The delay time in this case is shorter than with Chorus, however, which means that the effect is more in the normal sound sphere. The cyclical shift of two signals which are identical in principle results in phase cancellations, so-called comb-filter effects. Modulation via an LFO causes these cancellations to shift, resulting in Flanging.

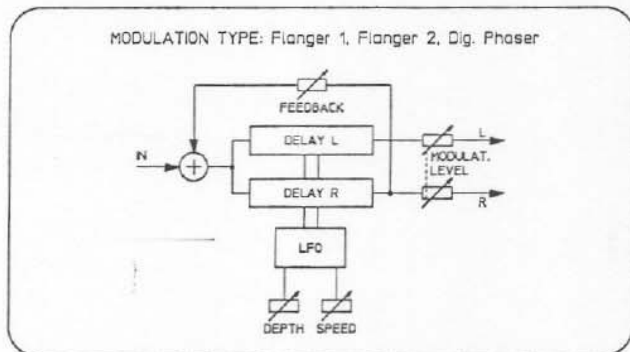

PHASER:

The Phaser is based on the Flanger structure but possesses other settings.

ROTO FLANGER:

The Roto Flanger can be used to simulate the effect of rotating loudspeakers. It is based on the Flanger principle, but possesses additional taps within the delay line. Modulation of the delay via an LFO simulates rotating loudspeakers.

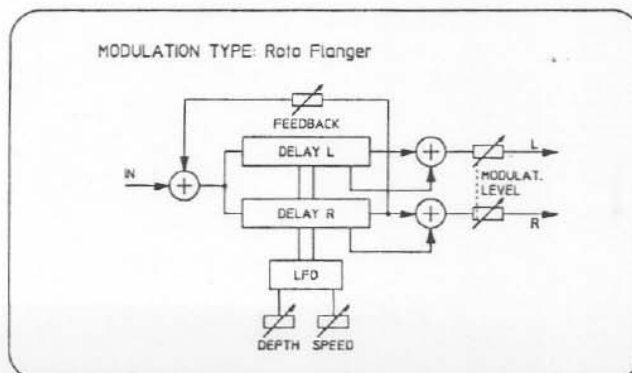

SPACE:

The Space effect is also based on the principle of a modulated delay. In this case, however, two LFO's are active, whereby the LFO2 is coupled to the LFO1. This means multiple modulation of the delayed signal and mix with the direct signal subsequently. This creates a stronger sound colouration than with the modulation effects described hitherto.

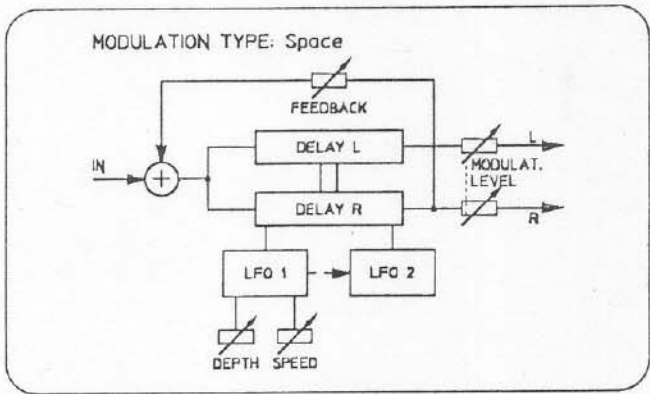

MODULATION LEVEL

This parameter determines the volume of the modulation effect. The readings appear in dB.

Valuation range: 0 dB - -48dB, -OFF-

01

MODULAT LEVEL ■■■■ -12 dB

MODULATION TYPE

The various modulation types can be set here. For further details please turn to the chapter entitled "MODULATION".

Settings: Chorus SL
Chorus 1
Chorus 2
Space
Flanger 1
Flanger 2
Phaser
Roto Flanger

01

MODULAT TYPE Chorus SL

with Multi-Effect: Stereo Chorus
Mono Chorus
Stereo Flanger
Mono Flanger
Stereo Phaser
Mono Phaser

MODULATION DEPTH

This parameter serves to set the modulation depth or width. The readings appear in relative values.

Valuation range: 0 -10

01

MODULAT DEPTH ■■■■ 10

MODULATION SPEED

This parameter determines the modulation speed or frequency. The readings appear in Hz.

Valuation range: 0.1 Hz - 10.0 Hz

01

MODULAT SPEED ■ 2.5 Hz

MODULATION FEEDBACK

This parameter determines the strength of the feedback. If a negative value is set, a phase inversion occurs within the feedback loop. Readings appear in %.

Valuation range: -99% - +99%

01

MODULAT FEEDB ■■■ 50%

7.2.5 PITCH SHIFT

The Pitch Shifter is used to add up to two additional tones to the direct signal. The interval can be set from minus one octave to plus one octave. Fine-tuning of +/- 50% of a semi-tone is also possible.

The following parameters are available:

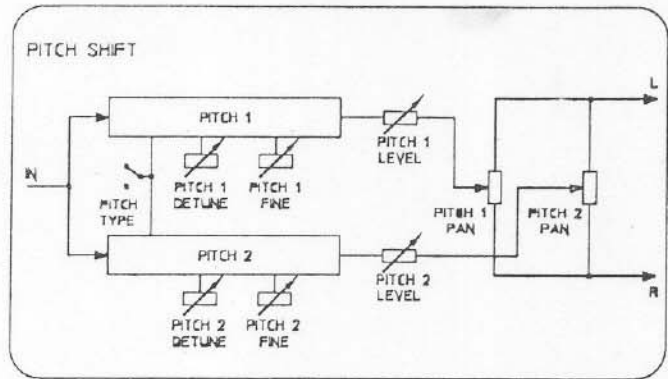

PITCH 1 LEVEL

This parameter determines the level of the first signal transposed.

The setting is made in dB.

Valuation range: 0dB - -48dB, -OFF

01



PITCH 1 PAN

This is used to position the Pitch Shifter 1 within the stereo sound image.

The setting is in relative values.

Valuation range: 10 L, L = R, 10 R

01

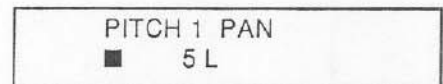

PITCH 1 DETUNE

This parameter is used to transpose the pitch of the direct signal upwards or downwards (maximum 1 octave higher or lower). The parameter determines the first transposition. (Pitch Shift 1).

The readings appear in steps of 1 semi-tone.

Valuation range: -12 - +12

01

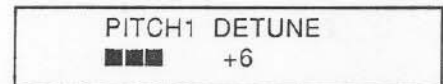

PITCH 1 FINE

This parameter effects fine-tuning or de-tuning of the added note in the first pitch shifter. This occurs in steps of cents. (1 Cent = 1 hundredth of a semi-tone). The readings appear in %.

Valuation range: -50%- + 50%

01



PITCH 2 LEVEL

This parameter determines the level of the second signal transposed.

The setting is made in dB.

Valuation range: 0 dB - -48dB, -OFF-

01

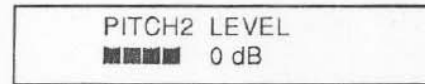

PITCH 2 PAN

This is used to position the Pitch Shifter 2 within the stereo sound image.

The setting is in relative values.

Valuation range: 10 L, L = R, 10 R

01

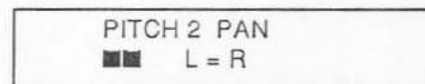

PITCH 2 DETUNE

This parameter is used to transpose the pitch of the direct signal upwards or downwards (maximum one octave up or down). The second transposition is determined by this parameter (Pitch Shift 2).

The readings appear in steps of 1 semi-tone.

Valuation range: -12 - +12

01

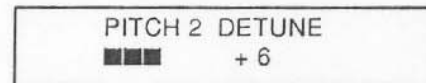

PITCH 2 FINE

This parameter effects fine-tuning or detuning of the note added in the second pitch shifter. This occurs in steps of cents. (1 Cent = 1 hundredth of a semi-tone). The readings appear in %.

Valuation range. -50%- + 50%

01

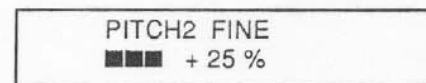

PITCH TYPE

The Pitch Shifter comprises two possible means of processing:

Fast Pitch
HQ Pitch

01

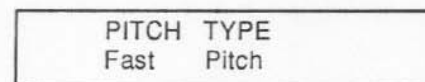

In the setting "Fast Pitch" an extremely fast algorithm is available to prevent the time delays of the transposed signal from becoming audible.

In "High Quality Pitch" a longer, more complex algorithm is used for transpose purposes. This serves to improve the quality of the transposed signal.

The selection of the most suitable mode depends on the sound material on hand and on the user's individual taste.

7.2.6 DELAY

The delay effect basically consists of one, or two, delay lines with adjustable feedback on the input.

It can be used to create fading echoes, ping-pong effects, doubling etc.

The following parameters are available:

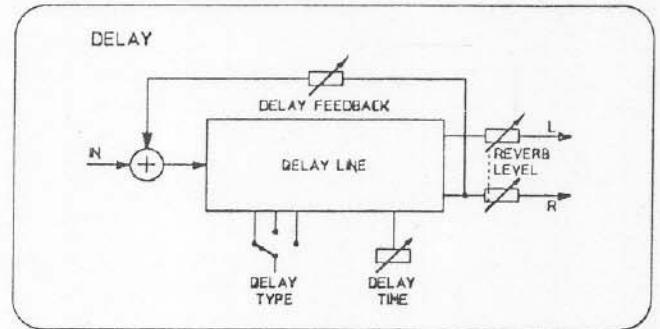

DELAY LEVEL

Determines the volume of the delay section. The readings appear in dB.

Valuation range: 0dB - -48 dB, -OFF-

01

DELAY LEVEL
■■■■■ 0 dB

DELAY TYPE

There is a choice between the following delay types:

- Mono
- Stereo 1
- Stereo 2
- Ping-pong

In "Mono" the delay times are identical in the left and right channel.

The "Stereo" setting creates slightly shifted delays for both outputs. In "Stereo 2" there are 2 feedbacks available. These are inter-related in a fixed ratio.

The "Ping-Pong" setting creates delays in the right and left channel alternatively.

01

DELAY TYPE
Pingpong

DELAY TIME

This parameter is used to set the delay time or the time in milliseconds elapsing between each individual delay.

Valuation range: 1 ms - 260 ms
1 ms - 600 ms (at Delay + Reverb)
1 ms - 1048 ms (at Long Delay)

01

DELAY TIME
■ 60 ms

DELAY FEEDBACK

Here the user can control the strength of the effect feedback to the input. In practice greater values increase the number of repetitions.

The readings appear in %.

Valuation range: +0% - +99%

01

DELAY FEEDBACK
■■■ + 50 %

DELAY- REVERB ROUTING

Dieser Parameter erscheint nur in der Struktur "DELAY+REVERB".

Sie können damit die Zuordnung des Delay Moduls und des Reverb Moduls zueinander bestimmen (siehe auch Kapitel 6, "EFFEKTSTRUKTUREN").

Folgende Einstellungen sind möglich:

Parallel

Delayed Rev

Bei "Parallel" werden das Delay Modul und das Reverb Modul quasi parallel betrieben.

Bei "Delayed Rev" werden das Delay Modul und das Reverb Modul hintereinander geschaltet. Die Echos werden somit "verhallt".

01

DEL- REV ROUTING
Front Reverb

7.2.7 DISTORTION

Im DRP 10 ist ein Verzerrer eingebaut, der sowohl röhrenähnliche als auch transistorähnliche Distortion-Sounds bietet.

Im Distortion-Modul ist auch ein Kompressor enthalten, der fest mit dem Distortion-Regler gekoppelt ist. Kompression und Distortion-Grad werden also immer zusammen eingestellt.

Folgende Parameter stehen zur Verfügung:

DISTORTION

Hiermit wählen Sie die Intensität der Verzerrung. Je größer der eingestellte Wert, desto stärker werden die Signale verzerrt.

Die Angaben erfolgen in relativen Werten.

Wertebereich: -OFF-, 1 -12

VOICE FILTER

Mit diesem Filter verändert man die Klangfarbe des verzerrten Signals. Es handelt sich um einen Tiefpaß mit einer Überhöhung im Durchlaßbereich. Die Filtereckfrequenz ist einstellbar. Bei kleinen Werten werden nur die tiefen Frequenzen durchgelassen, wodurch der Klang baßbetont wird. Je größer der eingestellte Wert, desto mehr Oberöne sind im Signal vertreten. In der Stellung "-OFF-" ist das Filter ausgeschaltet.

Die Frequenzangabe erfolgt in kHz.

Wertebereich: 1.0 kHz - 7.0 kHz, -OFF-

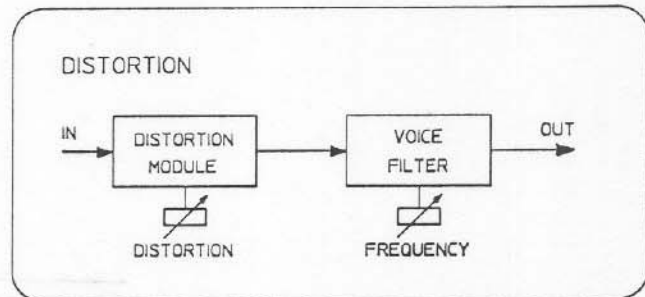

01

DISTORTION
■ 3

01

VOICE FILTER
■ ■ 4.0 kHz

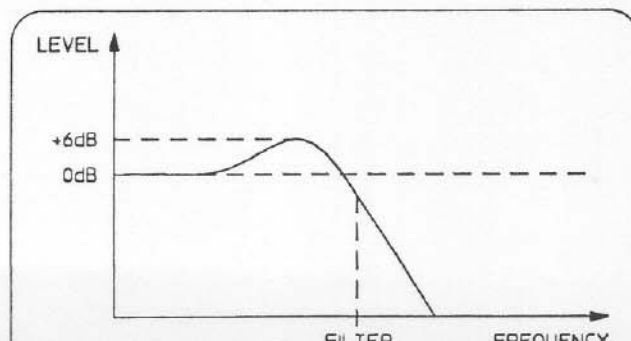

EFFECT LEVEL

This control determines the level of the whole effect signal in the configuration "Instrumental effect". The special arrangement of the individual effects in this structure necessitate this parameter, in order to set the effect ratio.

The readings appear in dB.

Valuation range: 0 dB - -60 dB, -OFF-

01

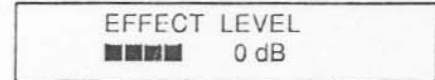

7.2.8 DELAY LINE 1 > 2

This is a delay line with one input and two outputs. The delay time or the signal running time and the volume can be set and stored separately for each output. A delay line is extremely useful when it is a matter of equalizing signal running times in large-scale sound reinforcement systems.

The following parameters are available:

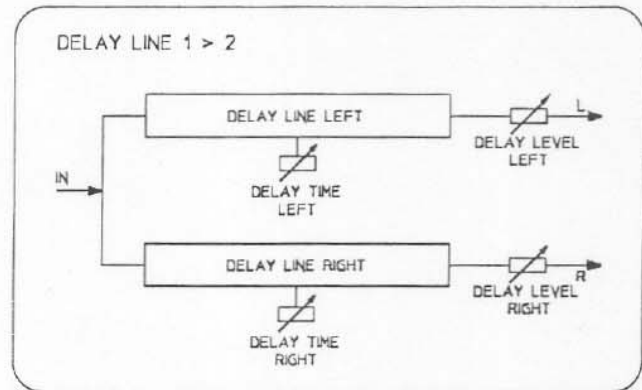

DELAY LEVEL LEFT

Determines the level of the delayed signal in the left channel. The readings appear in dB.

Valuation range: 0dB - -48 dB, -OFF-

01

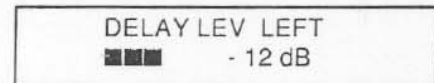

DELAY LEVEL RIGHT

Determines the level of the delayed signal in the right channel. The readings appear in dB.

Valuation range: 0dB - -48dB, -OFF-

01

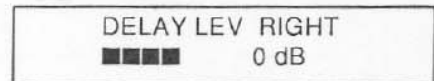

DELAY TIME LEFT

This is for setting the delay time or signal running time in the left channel. The readings appear in milliseconds, feet, inches, metres or centimetres.

Valuation ranges: 0 ms - 1048 ms
0 ft. - 1179 ft.
0 in. - 14155 in.
0 m - 359 m
0 cm - 32750 cm

01

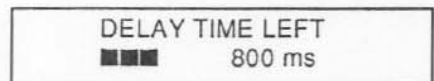

DELAY TIME RIGHT

This is used for setting the delay time or signal running time in the right channel. The readings appear in milliseconds, feet, inches, metres or centimetres.

Valuation ranges: 0 ms - 1048 ms
0 ft. - 1179 ft.
0 in. - 14155 in.
0 m - 359 m
0 cm - 32750 cm

01

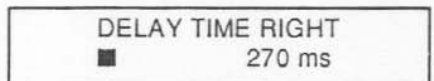

DELAY TIME UNIT

Here the user can choose the unit for the delay time.
Distance settings are automatically calculated into delay times.

Settings: milli-sec.
 feet
 inch
 meter
 centimeter

01

DELAY TIME UNIT — milli - sec.



8. OPTION FUNCTIONS

The Option programs comprise a whole number of important additional functions and pre-settings, such as how the DRP 10 should start after being switched on, whether the direct signal should be switched on or off, how the VU display should be set, etc.

- 1 Press both OPTION keys (9) and (10) simultaneously to activate the Option Program.

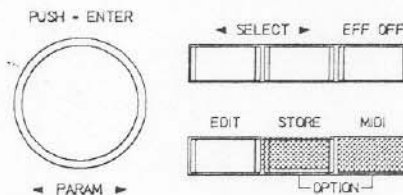

- 2 The Option Program used last appears on the display, e.g.:

01

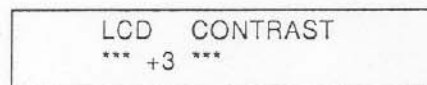

- 3 Find the Option required using the two SELECT keys (11, 12).
- 4 The rotary encoder (7) is used to set the Option values.
- 5 An Option program can be cancelled by pressing another MODE key, (e.g. return to Play Mode by pressing one of the effect group keys).

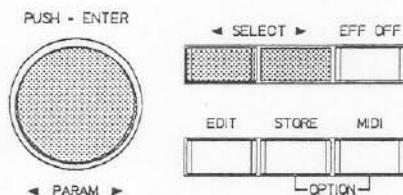

SWITCHING THE DIRECT SIGNAL ON/OFF

This function permits the user to use the DRP 10 as a pre-switched unit or looped device.

If you connect your instrument directly to the inputs of the DRP 10, the direct signal should be switched on, thus reaching the subsequent amplifier via the DRP 10.

If the DRP 10 is looped into the effect path of a mixing desk, the direct signal should be switched off, as it already reaches the master outputs in the mixing desk.

ORIGINAL ON:

The direct signal is switched on and appears in the stored volume value at the output. The DRP 10 can thus be used as a pre-switched unit.

ORIGINAL OFF:

The direct signal (parameter ORIGINAL LEVEL) is switched off with all programs. It appears in the display as "-OFF-". The stored values are of course preserved. This setting is for looping the DRP 10 into a mixing desk.

01

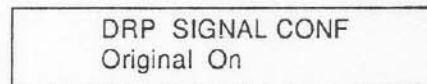

INDICATION OF THE SOFTWARE VERSION NUMBER

The display shows the software version of the DRP 10's processor, e.g. version 1.0.

01

DYNACORD DRP 10
Software V 1.0

SELECTION OF SWITCH-ON CONDITION:

TO VOCAL 01:

On being switched on and after reset, the DRP 10 always reports with the program VOCAL 01.

01

DRP 10 POWER ON
to VOCAL 01

TO LAST PROGRAM:

The DRP 10 always reports with the last program used, or with the status with which it was last switched off (except COPY, STORE, OPTION).

SETTING THE LCD CONTRAST

The LCD contrast or viewing angle can be adjusted between -10 (view from below) and +10 (view from above).

01

LCD CONTRAST
*** + 7 ***

DISPLAY MODE OF THE LEVEL INDICATOR

WITH PEAK:

The Peak-Hold Function is switched on. This will help you for setting up the level.

01

VU DISPLAY MODE
with peak

NO PEAK:

The Peak-Hold Function is switched off. The level display works normally.

SLOW:

In this setting the level display works with a long time constant, i.e. the decay of the indication is more slowly when the signal level is reduced.

FOOTSWITCH TABLE

In this table the sequence for a program selection with the UP/DOWN footswitch (e.g. FS 500) can be determined. Max. 20 program numbers can be assigned.

In the lower line of the display you can select between "Step" and program number with the SELECT buttons (11, 12). The next step or the appropriate program number is set via the rotary encoder.

01

FOOTSWITCH TABLE
St. 1 = VOCAL 03

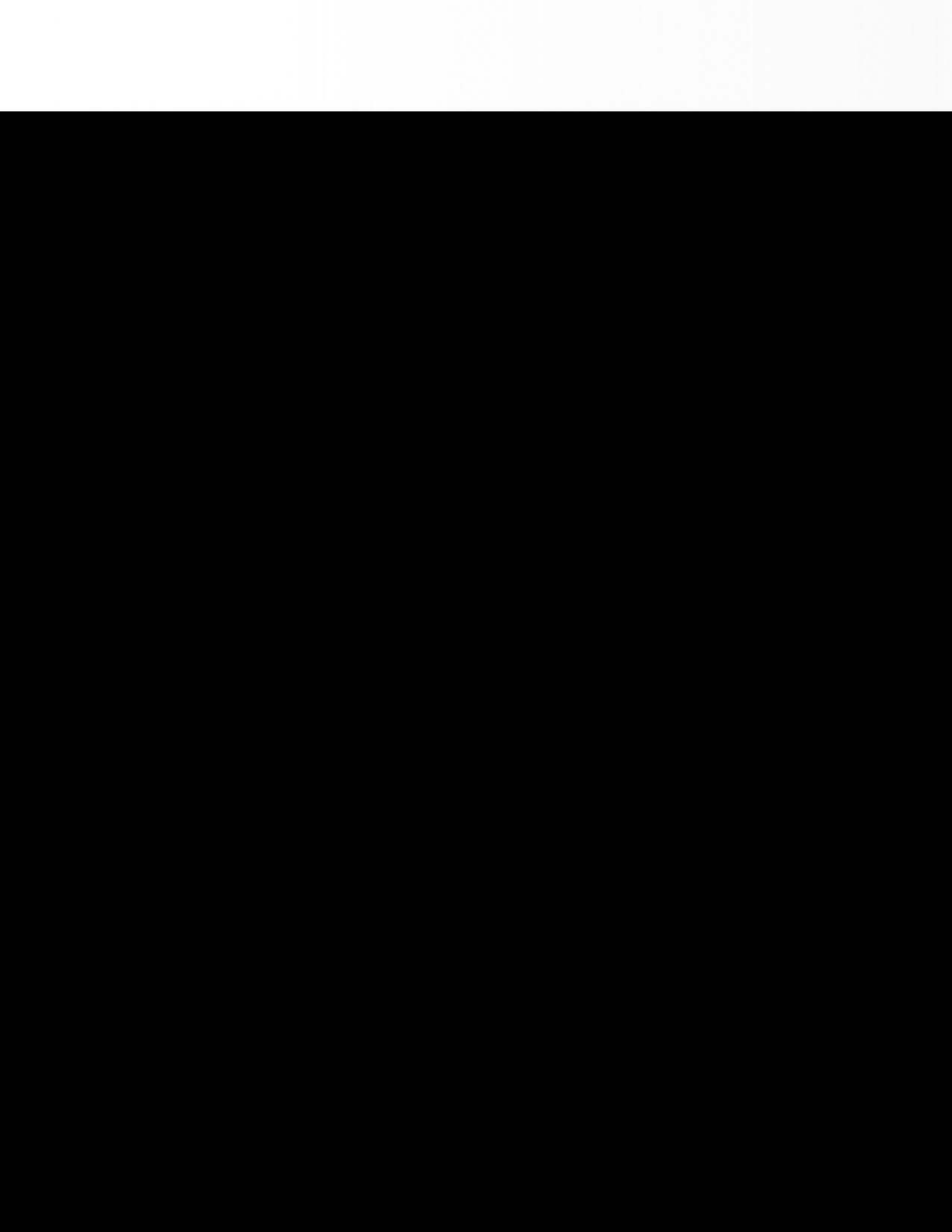

Following settings:

: :
: :

Step 20 USER 99

Footsw. Table is Off

End

- For the program change with footswitch no table is used. The programs are called up in the order VOCAL 01, VOCAL 02 USER 99.

- Here the table end is set if not all 20 possible inputs are used.

Example of a table with 5 steps:

- Step 1 : VOCAL 03
- Step 2 : VOCAL 28
- Step 3 : SPECIAL 02
- Step 4 : USER 32
- Step 5 : USER 33
- Step 6 : End (table end)

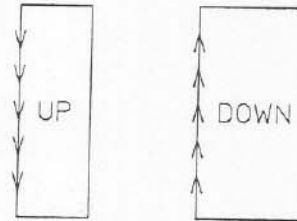

SELECTION OF PARAMETER UNITS

Here the units for the parameters REVERB ROOM SIZE and REVERB TIME can be selected.

IN CBM + SECONDS:

The unit for REVERB ROOM SIZE is cubicmetres; the unit for REVERB TIME is seconds.

IN RELATIVE VALS:

The parameters REVERB ROOM SIZE and REVERB TIME are indicated in percent values.

01

REVERB SIZE + TIME
in cbm + seconds

Here the units for the parameter DELAY TIME is set.

IN MILLISECONDS:

The unit for DELAY TIME is milliseconds.

IN BEATS PER MIN:

The unit for DELAY TIME is beats per minute (bpm).

01

DELAY TIME
in milliseconds

9. MIDI

The MIDI connection is made on the MIDI sockets IN/OUT/THRU (20). The MIDI functions in the DRP 10 allow the unit to be controlled externally. Due to the versatile and flexible possibilities, all the functions can be controlled from another MIDI unit (e.g. computer, sequencer, keyboard..), e.g.

- program change
- changing certain parameters
- switching the effect signal ON or OFF
- all controls (remote control of DRP 10)

and much more...

There are two different MIDI menus:

1. The **MIDI MAIN MENU** (see 9.2) to set all general MIDI data and for MIDI dump.
2. The **MIDI PATCH MENU** (see 9.3) which enables the user to allocate MIDI Patches to any program at random, in Edit Mode, i.e. which parameters are to be controlled by which MIDI controllers (MIDI standard).

If you should still be unfamiliar with MIDI operation, we suggest that you read about MIDI standards and interfaces in MIDI books, computer or music journals etc. to gather general information initially. There is also a brief explanation in the appendix of chapter 11.2.

9.1 GENERAL OPERATION

1. Press the MIDI key (10) to reach the MIDI menu in question.
 - the main MIDI Menu is accessible from the normal Play Mode.
 - the MIDI PATCH Menu is only accessible from Edit Mode.

The MIDI Mode is indicated in that the MIDI LED lights up.

2. The MIDI Function appears in the upper line of the display (title).

The parameters to be allocated appear in the lower line, e.g.:

3. The individual MIDI functions within a menu, and several parameters within one parameter line can be shifted along via the two SELECT keys (11, 12).
4. The rotary encoder is used to set the MIDI parameters.

All settings are active immediately!

Only for MIDI dump a confirmation by pressing ENTER is necessary.

5. You can leave the MIDI Menu by activating any other Mode key (OPTION, EDIT...)

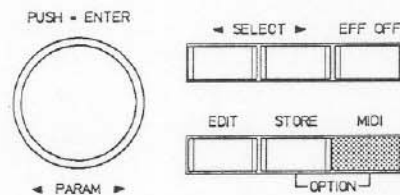

01

MIDI RECEIVE
CHANNEL : 2

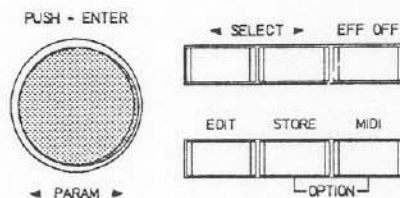
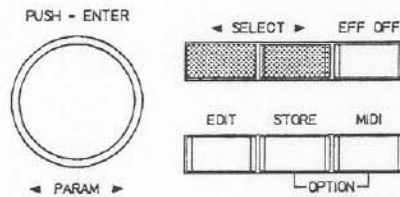

9.2 MIDI MAIN MENU

You can reach the MAIN MIDI Menu by pressing the key MIDI (10) from the Play Mode.

There are 4 MIDI functions within this menu. They can be selected successively using the SELECT keys (11) and (12).

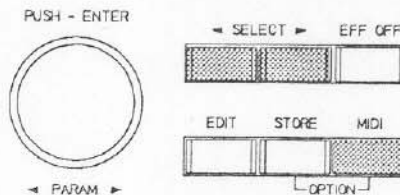

9.2.1 MIDI RECEIVE CHANNEL

This is used to set the MIDI channel on which the DRP 10 is to receive MIDI data. The setting is also valid for transmitting and receiving of System Exclusive Data (SysEx). The following appears on the display: e.g.:

01

MIDI RECEIVE
CHANNEL : 2

The following settings are possible via the rotary encoder:

- OFF** - The DRP 10 does not react to any MIDI data. SysEx is switched off.
- OMNI** - The DRP 10 receives MIDI data on all 16 MIDI channels. SysEx data are transmitted on channel 1.
- 1 - 16** - The DRP 10 only receives MIDI data on the MIDI channel selected between 1 and 16. For transmitting of SysEx data this setting is also valid.

If the DRP 10 is programmed to MIDI reception, the MIDI LED lights up as soon as data is transmitted to the DRP 10. The MIDI LED also serves to check that the MIDI connection is correct.

9.2.2 MIDI PROGRAM TABLE

This MIDI function can be used to draw up an allocation table in which the 128 general MIDI program numbers are assigned at random to 128 of the DRP 10's programs. The display shows e.g.:

01

MIDI PRG TABLE
001 = VOCL 01

This example means that the reception of a MIDI PROGRAM CHANGE with the number 001 calls up the program VOCAL 01 in the DRP 10.

The following settings are possible:

MIDI No.		DRP 10 program
001		VOCL 01
.		.
.		.
.	=	.
.		.
.		.
.		USER 99
128		no change

- Direct Bank *)** - The MIDI program numbers call up the DRP 10's programs of the group currently active.
- Progr Change Off** - The DRP 10 does not react to any MIDI PROGRAM CHANGE commands.

*) Via Bank Select (MIDI Controller 0) you can switch between the effect groups.

Example of a table:

- 001 = VOCL 09 (factory program)
- 002 = VOCL 12 (factory program)
- 003 = SPEC 50 (user program)
- 004 = no change (MIDI program numbers are ignored; no program charge)
- 128 = USER 07 (user program)

9.2.3 MIDI DUMP

This function serves to transfer the data from an individual program, all User programs or all system data and tabular settings via MIDI.

To do so, however, the MIDI OUT socket of the DRP 10 must be connected to the MIDI IN socket of a device which can process this data. (e.g. another DRP 10, computer etc.)

The following may appear on the display:

The following settings can be made with the rotary encoder:

- Current Program** - the data from the program currently active are transferred.
- All User Progs** - the data of all User programs can be transferred entirely.
- System Data + Tab** - here all system data e.g. OPTION settings and all the contents of tables (foot switch table, MIDI table) can be transmitted via the MIDI interface.

By pressing the rotary encoder (= ENTER) MIDI DUMP is activated, and the selected data are then transferred accordingly.

During the transmission the display shows:

Transfer of all data takes approximately 8 seconds and then the display returns to its original condition.

9.2.4 MIDI IN MONITOR

In this function, MIDI data received is indicated on the display in the order in which the data was received, e.g.

Here the user also has the possibility to trace errors by checking the outputs of the various MIDI units in turn to see if they are functioning correctly.

01

MIDI DATA DUMP
Current Program

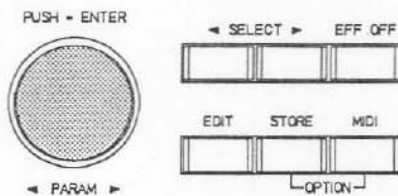

01

Sending MIDI
Data Dump...

01

MIDI IN MONITOR
C0 01 85 01 80

9.3 MIDI PATCH-MENÜ

All DRP 10 parameters can be altered in realtime by any MIDI device. To do so, the MIDI controllers are allocated to the effect parameters in edit mode. This is known as a Controller patch.

A Patch consists of a Controller and its setting range (Range: 100% - + 100%) and the effect parameters allocated. A maximum of 4 Controller Patches can be allocated to each program. If a fifth Patch is set, the one set first is deleted.

The settings always only apply to the program in question and are stored together with the parameters in the appropriate program memory place.

In addition to the MIDI Controllers and other MIDI messages the foot pedal can also be used as a Controller (see Chapter 10, REMOTE CONTROL). "DRP Pedal" must be set as the Controller, the setting range also equalling -100% - + 100%).

The following Controllers are available:

0 = Bank Select	64 = Damper Pedal
1 = Modulation Wheel	65 = Portamento
2 = Breath Controller	66 = Sostenuato
3 = Controller 3	67 = Soft Pedal
4 = Foot Controller	68 = Legato
5 = Portamento Time	69 = Hold 2
6 = Data Entry	70 = Sound Controller 1
7 = Main Volume	71 = Sound Controller 2
8 = Balance	72 = Sound Controller 3
9 = Controller 9	73 = Sound Controller 4
10 = Pan	74 = Sound Controller 5
11 = Expression Controller	75 = Sound Controller 6
12 = Effect Controller 1	76 = Sound Controller 7
13 = Effect Controller 2	77 = Sound Controller 8
14 = Controller 14	78 = Sound Controller 9
15 = Controller 15	79 = Sound Controller 10
16 = General Purpose Controller #1	80 = General Purpose Controller #5
17 = General Purpose Controller #2	81 = General Purpose Controller #6
18 = General Purpose Controller #3	82 = General Purpose Controller #7
19 = General Purpose Controller #4	83 = General Purpose Controller #8
20 = Controller 20	84 = Portamento
21 = Controller 21	85 = Switch 85
22 = Controller 22	86 = Switch 86
23 = Controller 23	87 = Switch 87
24 = Controller 24	88 = Switch 88
25 = Controller 25	89 = Switch 89
26 = Controller 26	90 = Switch 90
27 = Controller 27	91 = Effect 1 Depth
28 = Controller 28	92 = Effect 2 Depth
29 = Controller 29	93 = Effect 3 Depth
30 = Controller 30	94 = Effect 4 Depth
31 = Controller 31	95 = Effect 5 Depth
	Note Off
	Note On
	Poly Pressure
	Velocity
	Release
	Channel Pressure
	Pitch Wheel
	DRP 10 Pedal

The MIDI Patch menu is only accessible via Edit mode. First press the key EDIT (8), then MIDI (10). The LED's EDIT and MIDI then light up.

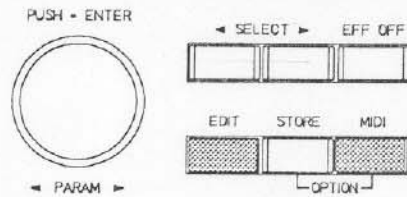

The following may appear on the display, for example:

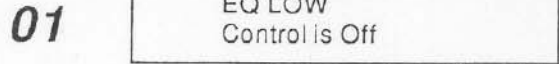

This means that no MIDI Controller is allocated to the Parameter EQ LOW at the moment.

If you wish to allocate a MIDI Controller to the parameter on the display, select the desired controller via the rotary encoder. Use the SELECT keys (11) and (12) to get to another parameter.

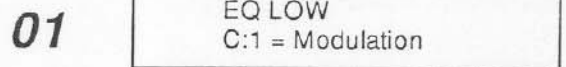
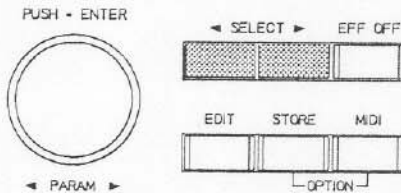

Whilst selecting a MIDI Controller by means of the rotary encoder, the controller's designation appears in the display (see table), followed approximately 1 second later by the controller number, together with the setting range, e.g:

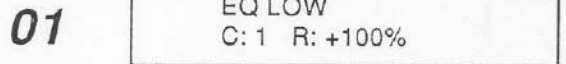

Now set the required MIDI controller and switch to the range value via the SELECT > key (12). The range can be set via the rotary encoder between - 100% and + 100%.

Range indicates the setting range in %, whereby the parameter is adjusted downwards in the minus range and upwards in the plus range. 100% always corresponds with the total range of the parameter in question.

An example:

If the parameter REVERB LEVEL has been set at -6dB, and if the MIDI Controller 1 (Mod.Wheel) is programmed at -50%, the REVERB LEVEL is altered with the modulation wheel of a keyboard from -6 dB to -30 dB.

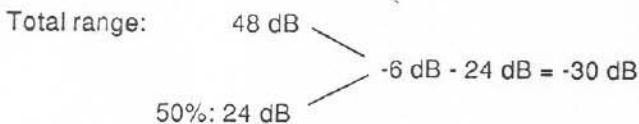

The SELECT keys can be used at any time to switch over between Controller Number and Range. If the cursor is already on Range, SELECT > (12) provides access to the next parameter.

Once you have set the MIDI Patches you need, the program can be stored on a USER memory place as described under chapter 5.3.

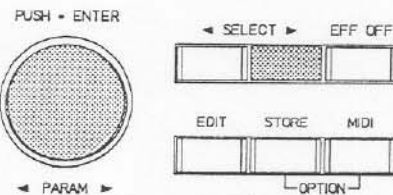

IMPORTANT!

Always make sure that the MIDI channel of the control unit corresponds with the receive channel of the DRP 10. Otherwise MIDI control is not possible.

9.4 MIDI data format

This chapter contains information for programmers who wish to write software for the DRP 10. All the commands are defined which are needed to transmit or receive data via the MIDI interface.

A MIDI data transfer is only possible if a MIDI receive channel has been set (OMNI, 1 - 16). With MIDI RECEIVE CHANNEL:OFF no communication takes place via the MIDI interface. (see chapter 9.2.1).

General MIDI commands:

Program Change	MIDI-Byte	Description
	Cn (hex)	n = MIDI Channel 0-15
	0xxx xxxx (bin)	Bank 0-7 : 0..49 = PGM 1..50 Bank 8 : 0..98 = USER1..99

Random allocations of MIDI program numbers to DRP 10 programs are possible in the MIDI program table. (see chapter 9.2.2).

Bank Select (Controller 0)	MIDI-Byte	Description
	Bn (hex)	n = MIDI Channel 0-15
	20(hex)	Controller 0 (LSB)
	0000 nnnn (bin)	n = 0..7 : Banks VOCAL - SPECIAL n = 8 : USER Bank

The Inst. Groups are selected via Controller 0. This alteration takes effect after the next Program Change.

MIDI System Exclusive Implementation:

Identity Request (recognized)	MIDI-Byte	Description
	F0 (hex)	System Exclusive
	7E	Universal System Exclusive Non-real time header
	0n	n = MIDI Channel 0-15 (7F = All Channels)
	06	General Information
	01	Identity Request
	F7	End of SysEx Message

This command sequence requests the DRP 10 to report its identity number.

Identity Reply (transmitted when Identity Request is received)	MIDI-Byte	Description
	F0 (hex)	System exclusive
	7E	Universal System Exclusive Non-real time header
	0n	n = MIDI Channel 0-15 (7F = All Channels)
	06	General Information
	02	Identity Reply
	30	DYNACORD ID: No 48
	0A	DRP 10 ID: No 10
	DEV_CODE	Reserved 3 Byte Device code
	REVISION	Revision: 4 Digit ASCII Code
	F7	End of SysEx Message

The DRP 10 transmits this identity code in answer to an Identity request. The following numbers are transmitted: DYNACORD ID no. 48, the DRP 10 Device ID no. 10, a 3-byte device code no. and the revision no.

Dumps:

Current Program Dump Request	MIDI-Byte	Description
(recognized)	F0 (hex)	System exclusive
	30	DYNACORD ID: No 48
	0n	n = MIDI Channel 0-15 (7F = All Channels)
	0A	DRP 10 ID: No 10
	11	Function ID: Current Program Dump Request
	F7	End of SysEx Message

This command sequence requests the DRP 10 to transmit the program currently in the buffer.

Current Program Dump	MIDI-Byte	Description
(recognized +transmitted)	F0 (hex)	System exclusive
	30	DYNACORD ID: No 48
	0n	n = MIDI Channel 0-15 (7F = All Channels)
	0A	DRP 10 ID: No 10
	31	Function ID: Current Program Dump
	DATA	8/7 Code (72 Data Byte)
	CHECKS	Checksum of Received DATA (7 bit, 2's Compl)
	F7	End of SysEx Message

Here only the program currently in the buffer is transmitted or received.
USER programs are not altered.

Single Program Dump Request	MIDI-Byte	Description
(recognized)	F0 (hex)	System Exclusive
	30	DYNACORD ID: No 48
	0N	MIDI ChannelNr: 0-15: 0x7F = All Channel
	0A	DRP 10 ID: No 10
	14	Function ID: Single Program Dump Request
	S-BANK SOURCE	0-7= Vocal..Special, 8 = User Bank Bank0-7: Program Nr 30..50 Bank 8: Program Nr 1..99
	D-BANK DESTIN	0-7= Vocal..Special, 8 = User Bank Bank 0-7: Program N 30..50 Bank 8: Program Nr 1..99
	F7	EOX

This command sequence requests the DRP 10 to transmit the program specified by bank and program number.

Single Program Dump	MIDI-Byte	Description
(recognized + transmitted)	F0	System exclusive
	30	DYNACORD ID: No 48
	0N	MIDI ChannelNr: 0-15: 0x7F = All Channel
	0A	DRP 10 ID: No 10
	34	Function ID: Single Program Dump
	D-BANK DESTIN	0-7= Vocal..Special, 8 = User Bank Bank 0-7: Program N 30..50 Bank 8: Program Nr 1..99
	DATA	8/7 Code (72 Byte)
	CHECKS	Checksum of Received DATA (7 bit, 2's Compl)
	F7	EOX

A special program specified by program numbers is transmitted or received.
The corresponding USER program is overwritten.

All User Programs Dump Request (recognized)	MIDI-Byte	Description
	F0 (hex)	System exclusive
	30	DYNACORD ID: No 48
	0n	n = MIDI Channel 0-15 (7F = All Channels)
	0A	DRP 10 ID: No 10
	12	Function ID: All Programs Dump Request
	F7	End of SysEx Message

This command sequence requests the DRP 10 to transmit all 259 USER programs.

All User Programs Dump (recognized + transmitted)	MIDI-Byte	Description
	F0 (hex)	System exclusive
	30	DYNACORD ID: No 48
	0n	n = MIDI Channel 0-15 (7F = All Channels)
	0A	DRP 10 ID: No10
	32	Function ID: All Programs Dump
	DATA	8/7 Code
	CHECKS	Checksum of Received DATA (7 bit, 2's Compl)
	F7	End of SysEx Message

The DRP 10 transmits or receives all 259 USER programs. This procedure lasts approx. 8sec.
All USER programs are overwritten.
The program currently in the buffer is not altered.

System Data + Tables Dump Request (recognized)	MIDI-Byte	Description
	F0 (hex)	System exclusive
	30	DYNACORD ID: No 48
	0n	n = MIDI Channel 0-15 (7F = All Channels)
	0A	DRP 10 ID: No 10
	13	Function ID: System Data Dump Request
	F7	End of SysEx Message

This command sequence requests the DRP 10 to transmit all system data and table contents.

System Data + Tables Dump (recognized +transmitted)	MIDI-Byte	Description
	F0 (hex)	System exclusive
	30	DYNACORD ID: No 48
	0n	n = MIDI Channel 0-15 (7F = All Channels)
	0A	DRP 10 ID: No 10
	33	Function ID: System Data Dump
	DATA	8/7 Code (256 Data Byte)
	CHECKS	Checksum of Received DATA (7 bit, 2's Compl)
	F7	End of SysEx Message

Here no program data are transmitted, but exclusively system data like set e.g. in OPTION Mode or in the MIDI program table.

Dump Processed (recognized + transmitted)	MIDI-Byte	Description
	F0 (hex)	System exclusive
	30	DYNACORD ID: No 48
	0n	n = MIDI Channel 0-15 (7F = All Channels)
	0n	DRP 10 ID: No 10
	20	Function ID: Dump Processed
	F7	End of SysEx Message

This information is transmitted if a dump was received or processed.

Others:

Store Request (recognized)	MIDI-Byte	Description
	F0 (hex)	System exclusive
	30	DYNACORD ID: No 48
	0n	n = MIDI Channel 0-15 (7F = All Channels)
	0A	DRP 10 ID: No 10
	15	Function ID: Store Request
	BANK NUMBER	Destination Group Bank 0-7: Program Nr 30..50 Bank 8: Program Nr 1..99
	F7	End of SysEx Message

Here the currently buffer content is saved under the specified USER program number.

Store Processed (recognized + transmitted)	MIDI-Byte	Description
	F0 (hex)	System exclusive
	30	DYNACORD ID: No 48
	0n	n = MIDI Channel 0-15 (7F = All Channels)
	0A	DRP 10 ID: No 10
	25	Function ID: Store Processed
	F7	End of SysEx Message

Is transmitted if the store procedure is terminated.

Single Parameter adjust (recognized + transmitted)	MIDI-Byte	Description
	F0 (hex)	System exclusive
	30	DYNACORD ID: No 48
	0n	n = MIDI Channel 0-15 (7F = All Channels)
	0A	DRP 10 ID: No 10
	30	Function ID: Parameter adjust
	0nnn nnnn (bin)	Parameter Number (s. Table)
	0xxx xxxx	7 bit Data LSB (0-127)
	0xxx xxxx	7 bit Data MSB (not necessary)
	F7	End of SysEx Message

Here a special parameter of the program currently in the buffer is altered.

Parameter Numbers (decimal):

0	ORIGINAL LEVEL			
1	EQ LOW			
2	EQ HIGH			
3	REVERB LEVEL		PITCH1 LEVEL	
4	REVERB TYPE		PITCH1 PAN	
5	REVERB ROOM SIZE		PITCH1 DETUNE	
6	REVERB TIME		PITCH1 FINE	
7	REVERB LF DAMP			
8	REVERB HF DAMP			
9	REFL-REV RATIO	DELAY LEVEL		
10	REFLECTION TYPE	DELAY TYPE		
11	REV-CLUSTER PROP	DELAY TIME		
12	REVERB PREDELAY	DELAY FEEDBACK		
13	REFL-REV DELAY	MODULATION LEVEL	PITCH2 LEVEL	PITCH BALANCE DEL-REV-ROUT
14	REVB GATE TIME	MODULATION TYPE	PITCH2 PAN	
15	REVB GATE COLOR	MODULATION DEPTH	PITCH2 DETUNE	PITCH DETUNE
16	REVB GATE SLOPE	MODULATION SPEED	PITCH2 FINE	PITCH FINE
17	REVB GATE PREDLY	MODULATION FEEDB	PITCH TYPE	
18	DISTORTION			
19	VOICE FILTER			
20	EFFECT LEVEL			

MIDI Remote Control

(recognized)

MIDI-Byte	Description
F0 (hex)	System exclusive
30	DYNACORD ID: No 48
0n	n = MIDI Channel 0-15 (7F = All Channels)
0A	DRP 10 ID: No 10
77	Function ID: Remote (119)
0n	Remote Code (s. Table)
F7	End of SysEx Message

With this command a remote control of the front panel controllers (keys, rotary encoder) is possible. The DRP 10 reacts exactly same as if operated by the front panel control elements.

Remote Codes (decimal):

1	VOCAL	10	STORE
2	KEYB	14	MIDI
3	GUITAR	15	ENTER
4	BASS	18	OPTION
7	DRUMS	19	SERVICE
8	BRASS	32	ENCODER-DOWN
11	STRING	33	ENCODER-UP
12	SPECIAL		
16	USER		
5	DOWN		
9	UP		
15	ENTER		
13	EFF-OFF		
6	EDIT		

10. REMOTE CONTROL

10.1 REMOTE CONNECTIONS

With the DRP 10 the user has the possibility to use remote control of various functions via foot switch or pedal. The remote sockets are located at the rear of the housing.

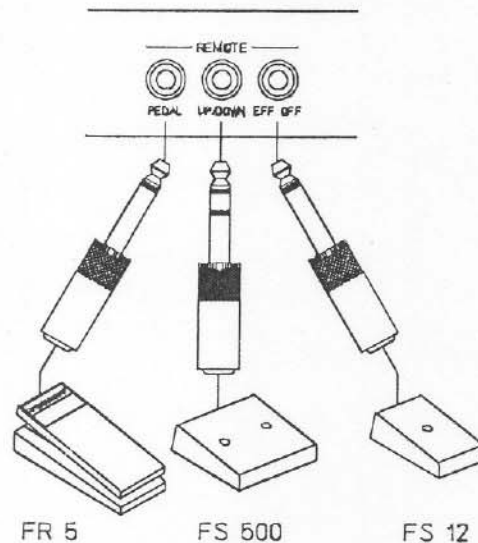

- UP/DOWN** - When connecting a double foot switch FS500 to this socket, the DRP 10's programs can be switched over. The order is fixed in the OPTION Menu. The program selected is loaded immediately.
- EFF OFF** - If a foot switch FS 12 is connected to this socket the Effect Off function can be activated. This is indicated by the Effect Off LED (also see chapter 5.5, EFFECT ON/OFF FUNCTION).
- PEDAL** - If a foot pedal FR 5 is connected to this socket, this serves to control parameters such as volume in realtime. The parameter can be programmed separately for every program. Turn to chapter 9.3 for a more detailed explanation.

Note:

Other foot switches apart from the specified FS 500 and FS 12 can be used, provided that they really have momentary contacts and not switches, and that the contact is closed on activation. (ON contact!)

As Pedals foot controllers with a nominal rating of between 75 kOhm and 150 kOhm should be used. The control range should be between 0 Ohm and the nominal rating.

11 APPENDIX

11.1 HOW IS REVERBERATION PRODUCED?

A sound signal is produced off by the sound source A. First the direct signal (double arrow) reaches the ear of listener B. With varying delay times the first reflections (single arrows) are then perceived (as echoes in larger rooms). The actual **reverberation** (open arrows) is then created by a very high density of many different time-delayed reflections. Within the reverberation the ear does not perceive the individual reflections as such. Depending on the wall structure, (or the reflecting object), a completely irregular diffusion can occur as shown at reflection point C.

The **duration** of the reverb mainly depends on the size of the room and the absorption qualities of its walls. In a large room the reflections travel further which of course takes longer.

The **reverb density** mainly depends on the properties of the room. An uneven or angular room gives off more varying reflections than a cube-shaped room for example.

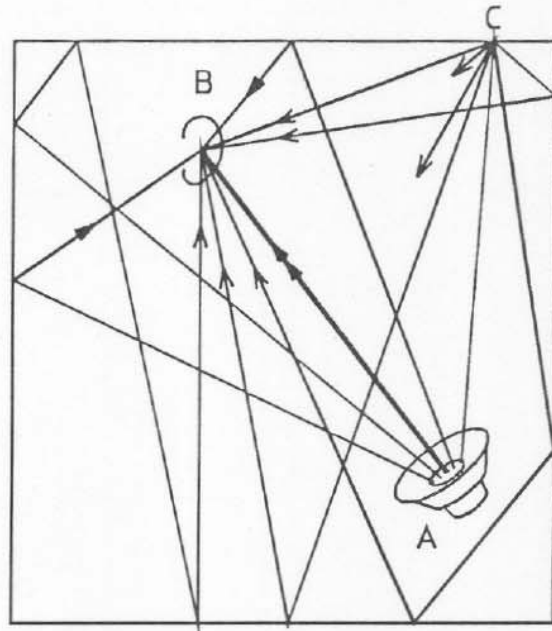

The timing of a reverb signal.

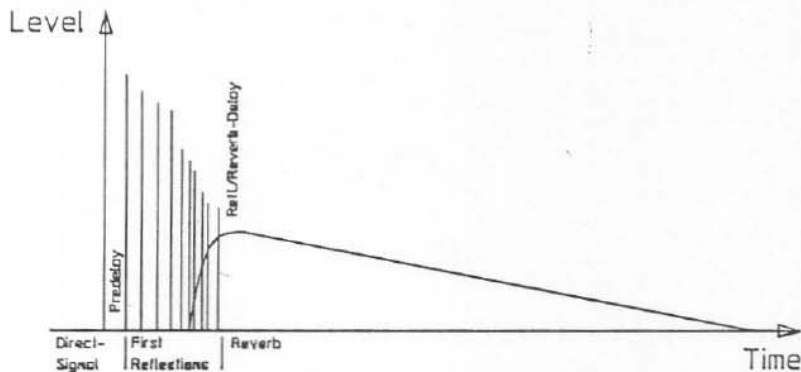

(Turn to chapter 7 to see the tasks of the individual parameters with the DRP 10)

11.2 WHAT IS MIDI?

As the name suggests, MIDI (Musical Instrument Digital Interface) is a standard data interface for musical instruments and devices.

In the general MIDI standard, MIDI Controllers, MIDI switches, MIDI Note numbers etc. are determined. As in computer technology, every MIDI event is given a certain address (bit order) which is recognized by all MIDI interfaces alike. Thus MIDI means a language which is also understood by units made by different manufacturers.

In most cases MIDI is used to play devices which produce sound (such as Expanders, Samplers, Synthesizers etc) from a keyboard. MIDI is used to transmit information to the units connected. Such information may include the note played, the position of the modulation wheel, the position of a foot pedal, the velocity with which the keys are played etc.

Effect units such as the DRP 10 can also be controlled via MIDI. They can be programmed in such a way that when a synthesizer sound is called up, the matching effect is also always selected. This is possible because when choosing a sound, the synthesizer transmits a program change command which is received by the DRP 10, which then calls up the program allocated to that particular command.

16 different channels are defined in the MIDI standard. Thus a MIDI transmitter can control up to 16 different MIDI reception devices at the same time, completely independently. You can set the MIDI reception channel on the DRP 10, (see chapter 9.2.1). For a correct MIDI operation the user must make sure that the appropriate MIDI channel is also set on the transmitting unit (Keyboard, Sequencer, Computer). Please read the operating instructions of the units in question.

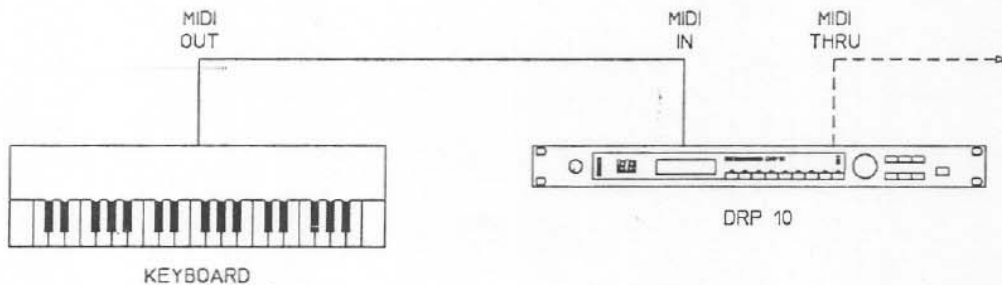

MIDI transmit channel: 01

MIDI receive channel: 01
Program change according MIDI program table

12.1 SPECIFICATIONS

Mains voltage	90 - 250 VAC / 50 - 60 Hz (without switching)
Power consumption	max. 15 W
Safety class	I
Rated input voltage	LINE 1.23 V / +4 dBu INSTR 390 mV / -6 dBu
Max. input voltage	9 V / +21 dBu
Input impedance	LINE 10 kohms INSTR 500 kohms
Rated output voltage	HI 2.45 V / +10 dBu LO 730 mV / -0.5 dBu
Max. output voltage	9 V / +21 dBu
Output impedance	120 ohms
Frequency response direct	20 Hz - 20 kHz +0 /-1 dB
Frequency response effect	20 Hz - 20 kHz +0 /-2 dB
S/N ratio direct	> 104 dB
S/N ratio effect	> 90 dB
Distortion (THD) direct	< 0.003%
Distortion (THD) effect	< 0.03%
Data format	16 bit linear, internal 24 bit
MIDI connectors	IN/OUT/THRU
Display	2 x 16 digit alpha-numerical LCD with LED back lit
Ground Lift	Disconnects ground from housing
Dimensions (W X H X D)	483 x 43.6 x 225 mm; 19" with 1 HU
Weight	3.5 kg / 7.7 lbs
Options	FS 500 (Up/Down) FS 12 (Effect off) FR 5 (Pedal)

The specifications for this product are subject to change without prior notice.

DYNACORD DRP 10 MIDI Implementation Chart V.1.0

Function..	Transmitted	Recognized	Remark
Basic Default Channel Changed	X X	1-16, -OFF- 1-16, -OFF-	Memorized
Mode Default Messages Altered	X X	Mode 1,3 X	Memorized
Note Number True voice	X	0-127	Used as Controller
Velocity Note ON Note OFF	X X	O O	Used as Controller
After Touch Key's Ch's	X X	O O	Used as Controller
Pitch Bend	X	O	Used as Controller
Control Change	X	0-31 64-95 32	Used as Controller Bank Select
Prog Change True#	X	0 - 127 00 - 49 00 - 98	Group Bank User Bank
System Exclusive	O	O	
System Common Song Pos Song Sel Tune	X X X	X X X	
System Real Time Clock Commands	X X	X X	
Aux Messages Local ON/OFF All Notes OFF Active Sense Reset	X X X X	X X X O	
Notes			
Mode 1 : OMNI ON, POLY Mode 2 : OMNI ON, MONO O : Yes			

SERVICE

- max. input voltage	EImax	=	9 V
		=	+21 dBu
- input level switch into position INSTR	EI	=	390 mV
		=	- 6 dBu
- max. input voltage	EImax	=	2.45 V
		=	+10 dBu

5. Outputs

- both outputs are connected (stereo operation)
- the output levels measured refer to an input level of EI = +4 dBu and f = 1 kHz (input level switch in LINE position, input control turned to the extreme right).

5.1. Output impedance ZO = 120 ohms

5.2. Output voltage

- output level switch into position HI

EO	=	2.45 V	
	=	+10 dBu	
- max. output voltage	EOmax	=	9 V
		=	+21 dBu

- output level switch into position LO

EO	=	730 mV	
	=	- 0.5 dBu	
- max. output voltage	EOmax	=	3.1 V
		=	+12 dBu

5.3. Frequency response

5.3.1. Frequency response - original signal	see page 23
5.3.2. Frequency response - effect signal	see page 23
5.3.3. Frequency response - EQ	see page 23

5.4 Distortion (THD)

5.4.1. Distortion (THD) - original signal	see page 24
5.4.2. Distortion (THD) - effect signal	see page 24

NOTE! Before carrying out the distortion factor measurement the unit must be allowed to warm up for a duration of 5 minutes and then the converter is adjusted to minimum distortion (THD) with the test program "P09".

5.5 Noise voltages

5.5.1 Noise voltage - original signal

Noise voltage (quasi peak level)	E_F	= 48 μ V = - 94 dB
CCIR 468 (quasi peak level)		= 100 μ V = - 88 dB
dB(A) (r.m.s.)		= 150 μ V = - 104 dB

5.5.2 Noise voltage - effect signal

Noise voltage (quasi peak level)	E_F	= 190 μ V = - 82 dB
CCIR 468 (quasi peak level)		= 350 μ V = - 76 dB
dB(A) (r.m.s.)		= 77 μ V = - 90 dB

5.5.3 Noise voltage - effect signal - zero out

Noise voltage (quasi peak level)	E_F	= 110 μ V = - 87 dB
CCIR 468 (quasi peak level)		= 220 μ V = - 81 dB
dB(A) (r.m.s.)		= 48 μ V = - 94 dB

5.5.4 Noise voltage - effect signal - effect off

Noise voltage (quasi peak level)	E_F	= 31 μ V = - 98 dB
CCIR 468 (quasi peak level)		= 80 μ V = - 88 dB
dB(A) (r.m.s.)		= 15 μ V = - 104 dB

6. Specifications

Mains voltage	90 - 250 VAC / 50 - 60 Hz (without switching-over)	
Power consumption	max. 15 W	
Safety class	I	
Input voltage	LINE	1.23 V / +4 dBu
	INSTR	390 mV / -6 dBu
Max. input voltage	9 V / +21 dBu	
Input impedance	LINE	10 kohms
	INSTR	500 kohms
Output voltage	HI	2.45 V / +10 dBu
	LO	730 mV / -0.5 dBu
Max. output voltage	9 V / +21 dBu	
Output impedance	120 ohms	
Frequency response - original	20 Hz - 20 kHz +0.5/-1 dB	
Frequency response - effect	20 Hz - 20 kHz +0.5/-2 dB	
S/N ratio - original	> 104 dB	
S/N ratio - effect	> 90 dB	
Distortion (THD) - original	< 0.003 %	
Distortion (THD) - effect	< 0.03 %	
Data format	16 bit linear, internally 24 bit	
MIDI sockets	IN/OUT/THRU	
Display	2 x 16 digit alphanumeric LCD backlit	
Ground lift switch	separates circuit ground from chassis	
Dimensions	483 x 43.6 x 225 mm (WxHxD), 19", 1 HU	
Weight	3.5 kg / 7.7 lbs	
Accessories	FS 500 (up/down)	
	FS 12 (effect off)	
	FR 5 (pedal)	

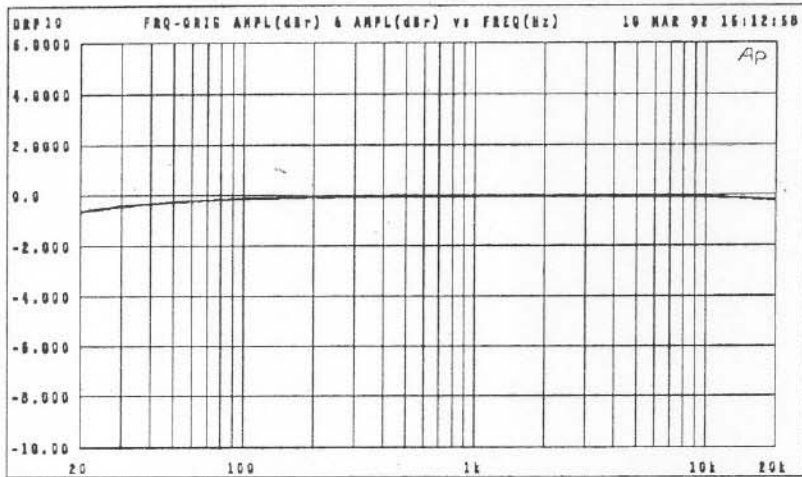

Frequency response original signal

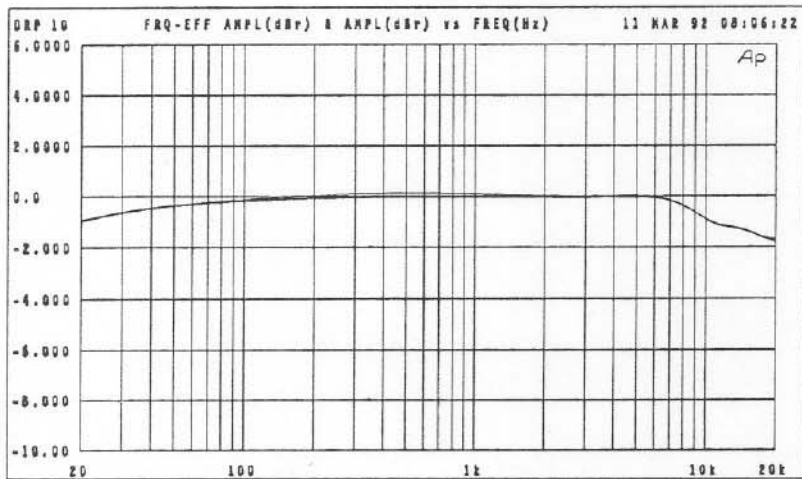

Frequency response effect signal

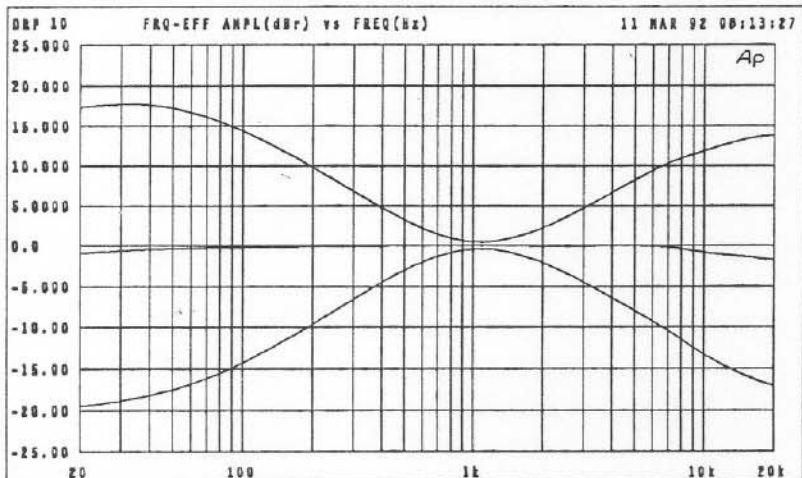

Frequency response effect linear / EQ +14 dB / EQ -14 dB

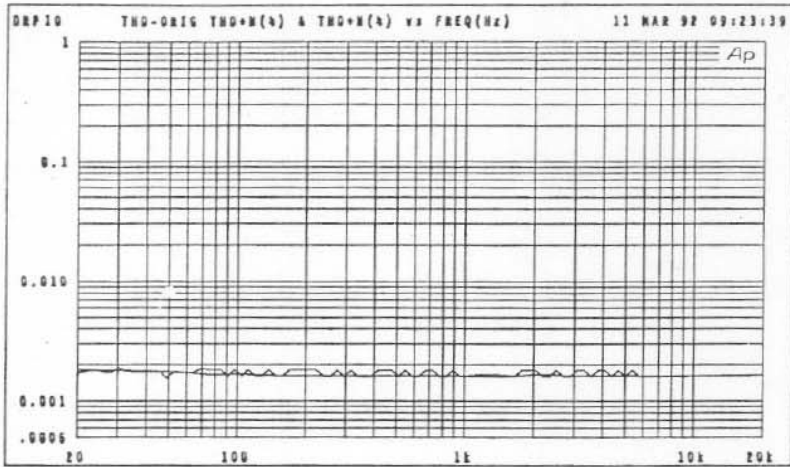

THD original signal

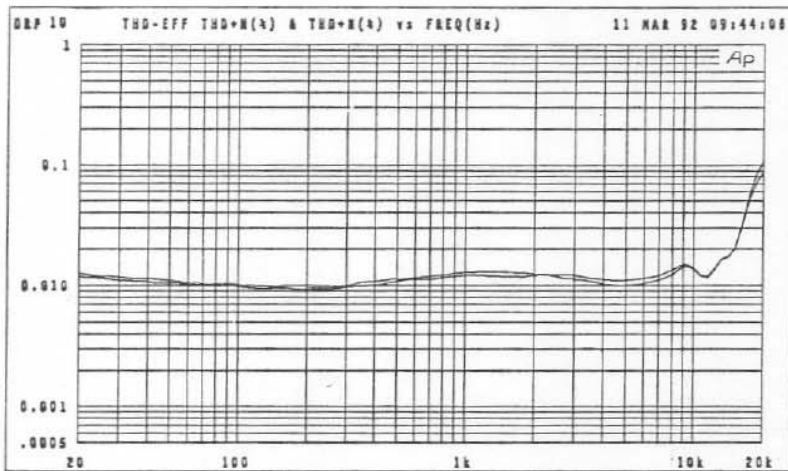

THD effect signal

DRP 10 Test Programs

The DRP-10 integrates several test programs to check internal function blocks.

Pressing the keys "BRASS" and "USER" at the same time gives access to the test mode. The following appears briefly in the display:

DRP 10 TEST MODE FOR SERVICE ONLY

The program number of each test is shown in the 7-segment display "P00" - "P16", P = test program). The test programs can be selected by means of the Select keys or by turning the rotary encoder and called up by "ENTER". Generally speaking, the "ENTER" key also serves to abort a test.

The test mode is exited in "P00" via "ENTER".

List of Test Programs:

P00	QUIT + RESET
P01	μP-ROM TEST
P02	μP-RAM TEST
P03	ARS RAM TEST
P04	BATTERY TEST
P05	MIDI TEST
P06	EFF-OFF TEST
P07	UP-DN TEST
P08	PEDAL TEST
P09	MSB ADJUST
P10	EFFECT SIGNAL
P11	ORIGINAL SIGNAL
P12	AUDIO TESTS
P13	LED TEST
P14	DISPLAY TEST
P15	KEY TEST
P16	ENCODER TEST

Explanations of the test programs:

Programm 00:

P00 QUIT + RESET
START = ENTER

This program serves to quit the test mode. When pressing "ENTER" the DRP 10 processor is given a reset and the unit is initialised. The user is then in play mode (the same as when the unit is switched on).

Program 01

P01 μ P-ROM TEST
START = ENTER

When "ENTER" is pressed the display changes to:

P01 Testing μ P-ROM
....

and the EPROMs of the host computer are checked. A check sum is calculated from the entire contents of the EPROMs. The test cannot be interrupted! If no error is found, the following appears in the display:

P01 μ P-ROM TEST OK !
<< >>

If an error is detected the following appears:

P01 μ P-ROM TEST FAIL
<< Checks:XXh >>

Program 02:

P02 μ P-RAM TEST
START = ENTER

This program serves to check the static RAMs in the DRP 10 processor system. To do so, various bit patterns are addressed to all RAMs and re-read.

NOTE! The RAM contents should be saved via Midi dump before the test is performed, as all data is lost during the test.

When "ENTER" is pressed the following appears in the display.

P02 Warning: Data in
RAM will be lost

By pressing "ENTER" again, the test program is started and the following appears in the display:

P02 Testing μ P-RAM
....

The test cannot be interrupted! If no error is found, the following appears in the display:

P02 μ P-RAM TEST OK !
<< >>

If an error is located, the display shows the first RAM address where a write/read error occurred.

P02 μ P-RAM TEST FAIL
<< at XXXXh >>

Program 03:

P03 ARS RAM TEST
START = ENTER

This program tests the DRP 10 effect chip (ARS 10) and the 6 static RAMs connected. The test lasts approx. 35 s but can be interrupted by pressing any key.

The following appears in the display:

P03 Testing ARS RAM
.....

If no error is located the following appears in the display:

P03 ARS RAM TEST OK!
<< >>

If this is not the case, several error messages can appear.

At the beginning of a test a bit test is carried out on the data bus. If an error is located in the course of this process the faulty data line (D00 - D23) appears in the display.

P03 ARS RAM FAILED !
on D XX

By pressing any key at random (apart from "ENTER" or "SELECT") the test can be continued after each error message.

Then the RAM bank 0 (U302, U303, U304) is written completely and re-read.

If an error is located during this process the first address where an error occurs appears in the display.

P03 ARS RAM FAILED !
at B0 0h

Then the RAM bank 1 (U305, U306, U307) is written completely and re-read.

If an error is located during this process the first address where an error occurs appears in the display.

P03 ARS RAM FAILED !
at B1 0h

Program 04:

P04 BATTERY TEST
START = ENTER

The DRP 10 incorporates a lithium battery to supply the static RAM with the necessary power when the unit is switched off. The battery voltage is constantly monitored and can be indicated on the display in this test. After the program has been called up via "ENTER", the following appears in the display:

P04 Testing BATTERY
U: 3.0V

The test is also aborted via "ENTER" and then the following appears on the display:

P04 BATT.TEST OK
<< >>

If the battery voltage drops to below 2.5 volts the following error message is displayed:

P04 BATT.TEST FAILED
<< >>

The battery should be changed as soon as possible.

Programm 05

P05 MIDI TEST
START = ENTER

For this test the MIDI-IN socket must be connected with the MIDI- Out socket via a MIDI cable. After pressing "ENTER" the test procedure is started and the following appears in the display:

P05 Testing MIDI

If there is an error during data communication the following appears.

P05 MIDI TEST FAILED
<< >>

Possible causes include a faulty MIDI cable, incorrect connection or a problem in the MIDI hardware of the DRP 10.

Program 06

P06 EFF-OFF TEST
START = ENTER

This test serves to check the remote control of the Effect Off function. To do so an Effect Off Foot switch must be connected to the appropriate socket at the rear of the unit. After calling up the test via "ENTER" the following request appears in the display:

P06 Switch EFF-OFF

If you then activate the switch, the following should appear in the display:

P06 EFF-OFF TEST OK
<< >>

If this should not be the case, there may be a fault in the foot switch connected or in the internal circuitry.

Program 07

P07 UP-DN TEST
START = ENTER

This test serves to check the UP/DOWN function. To do so an UP/DOWN foot pedal must be connected to the appropriate socket at the rear of the unit. After the test has been called up via "ENTER" the following appears in the display:

P07 Switch UP+DOWN

If you then activate both switches the following should appear in the display:

P07 UP/DN TEST OK
<< >>

If this is not the case there may be a fault in the foot switch or the internal circuitry.

Program 08

P08 PEDAL TEST
START = ENTER

This test serves to check the function of a connected foot pedal. If no controller has been connected to the appropriate socket at the rear of the unit and "ENTER" is pressed, the following appears in the display.

P08 Testing PEDAL
A/D:(221):off

As soon as a foot controller has been connected an A/D value between 000 and 127, depending on the position of the pedal, appears in the display. To carry out the test, the pedal must be moved as far as possible in both directions/must be moved to both extremes. The following then appears in the display:

P08 PEDAL TEST OK !
<< >>

Program 09:

**P09 MSB ADJUST
START = ENTER**

This test is to adjust MSB, thus also adjusting the distortion factor (THD) of the 16-Bit audio converter in the DRP 10.

For this test a triangular voltage with a level of -60dB (related to full modulation) and a frequency of 183 Hz is generated inside the unit. The Converter can be adjusted with the trimmer R302 by means of an oscilloscope connected at the output via a low pass filter. The test is called up and exited via "ENTER". During the test the following appears in the display:

**P09 TRIANGLE -60 dB
MSB adjust R302**

After adjustment a clearly defined triangle wave should appear on the oscilloscope.

Adjustment ok

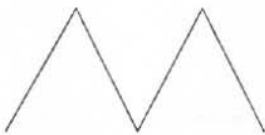

Adjustment wrong



Adjustment wrong

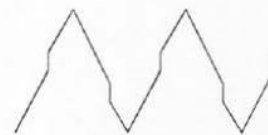

When exiting the test, the following appears in the display:

**P09 MSB ADJUST done
<< >>**

Program 10

**P10 EFFECT SIGNAL
START = ENTER**

In this program the effect path of the DRP 10 is activated in order to carry out audio measurements such as effect frequency response, distortion factor, S/N ratio etc. After "ENTER" has been pressed, the following appears in the display:

**P10 EFFECT ONLY
LEVEL: 0 dB**

The program is also exited via "ENTER" and then the following appears on the display:

**P10 EFFECT TEST done
<< >>**

Program 11:

**P11 ORIGINAL SIGNAL
START = ENTER**

In this program the DRP 10's original path is activated to carry out audio measurements such as original frequency response, distortion factor, S/N ratio etc. After "ENTER" has been pressed, the following appears in the display:

**P11 ORIGINAL ONLY
LEVEL: 0 dB**

The program is also exited via "ENTER" and then the following appears on the display:

**P11 ORIGIN TEST done
<< >>**

Program 12

**P12 AUDIO TESTS
START = ENTER**

This program offers a variety of settings for the DRP 10's audio path. The individual tests are selected either via the "SELECT" keys or via the rotary encoder knob. After pressing "ENTER", the following appears first of all.

**P12 ARS ORIG. THRU
without ALU**

Here, an unprocessed input signal appears on the outputs.

In the second sub-program the input signal is processed before it is fed to the outputs. Then, the following appears in the display:

**P12 ARS ORIG. THRU
with ALU**

In the next sub-program the input signal in the ARS 10 is amplified by 3 dB, (factor 1.5). This is indicated as follows:

**P12 ARS ORIG. THRU
+3 dB (x1,5)**

In the 4th sub-program a "Digital Null" is fed to the D/A converter. Here the signal-to-noise ratio of the D/A converter can be measured alone. The display indicates:

P12 ZERO OUT

The last sub-program displays the converter offset:

**P12 OFFSET TEST CMP
.....-..... ON**

The EFFECT ON/OFF key can be used to switch the internal offset compensation on and off

Program 13

P13 LED TEST
START = ENTER

This program serves to check all LED's on the front panel (status LED's, effect LED's, program display, level indicator). After pressing "ENTER", the following appears in the display:

P13 Testing LEDs

and the LED test starts with individual driving of the status and effect LED's. Then all LED segments are switched on. The 7- segment display shows "88". The program finishes automatically and then the following appears in the display:

P13 LED TEST done
<< >>

Program 14

P14 DISPLAY TEST
START = ENTER

This program serves to check the LC display and the contrast setting. After the program has started the LC display shows a graphic pattern. This is so the user can check whether all the pixels are being activated and are working properly. Then the following appears in the display:

P14 LCD CONTRAST :
:::: -00 ::::

With the aid of the rotary encoder the display contrast can be set in a range between -10 - +10. The test is exited via "ENTER" and the following appears in the display.

P14 DISP.TEST done
<< >>

The contrast value set is maintained even the unit is switched off.

Program 15

P15 KEY TEST
START = ENTER

This program serves to check the DRP 10 keyboard. When "ENTER" is pressed, the following appears in the display.

P15 Press all Keys

If a key is pressed then, the key designation appears in the 2nd line accordingly. After all the keys have been activated successfully the display shows:

P15 KEY TEST OK !
<< >>

The key test can be aborted at any time via "ENTER".

Program 16

P16 ENCODER TEST
START = ENTER

The rotary encoder can be tested with the aid of this program. After "ENTER" has been activated the display shows:

P16 Turn Encoder

When turning the encoder the direction and the counted impulses are displayed in the 2nd line. One full turn equals 20 impulses. "ENTER" is used to exit the program and the following appears in the display:

P16 ENC. TEST done
<< >>

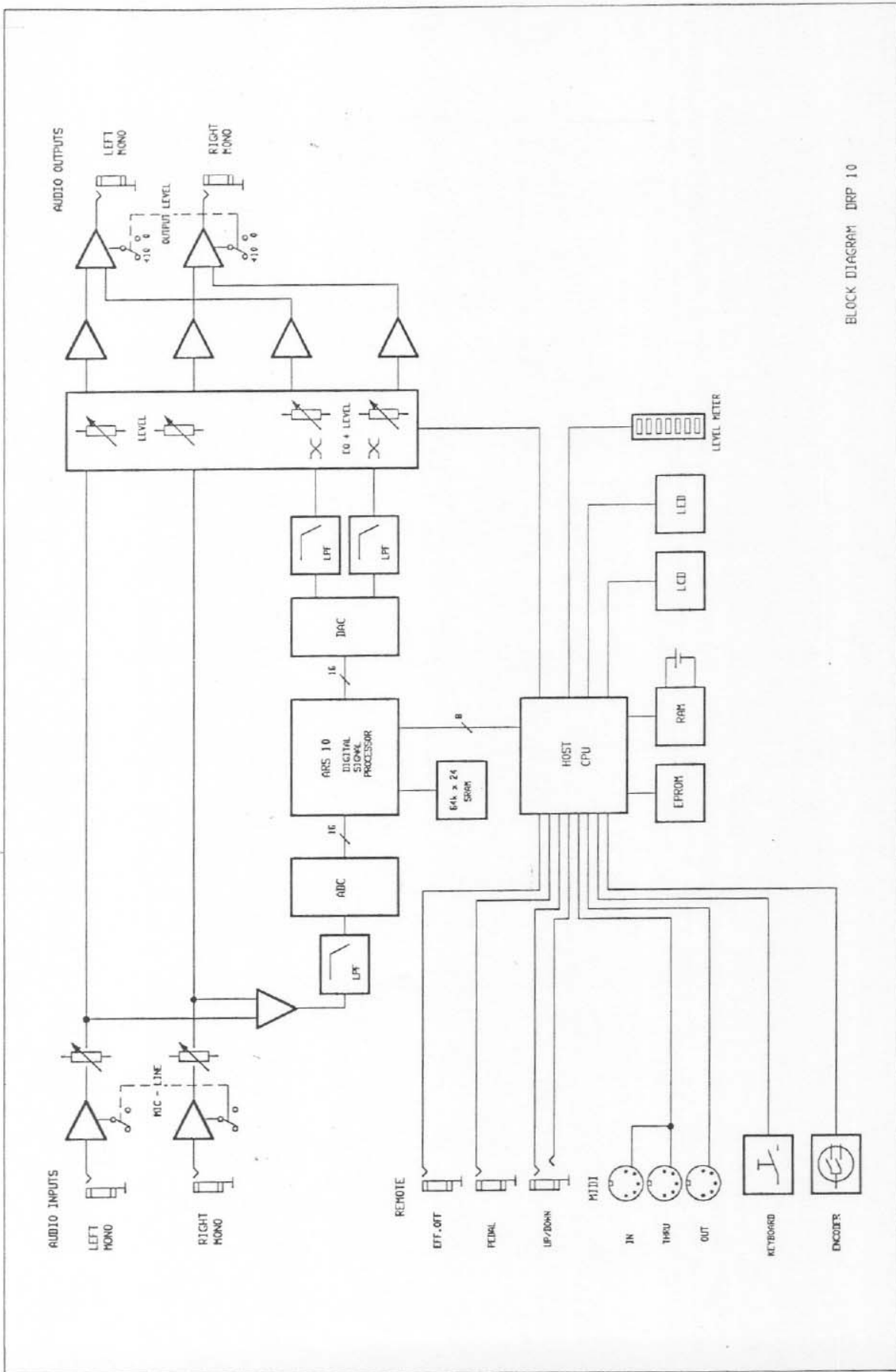

BLOCK DIAGRAM DRP 10

FRONT BOARD

CIRCUIT DIAGRAM · 344 848 · DRP 10

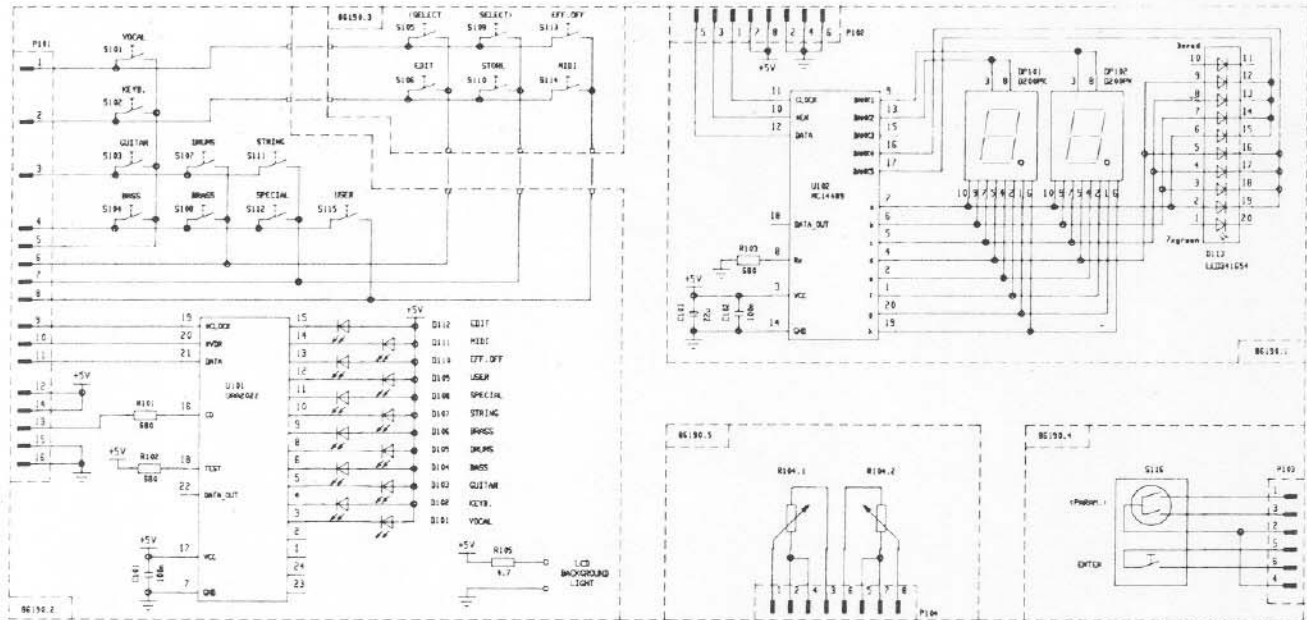

LINE FILTER

CIRCUIT DIAGRAM · 344 859 · DRP 10 / DRP 10

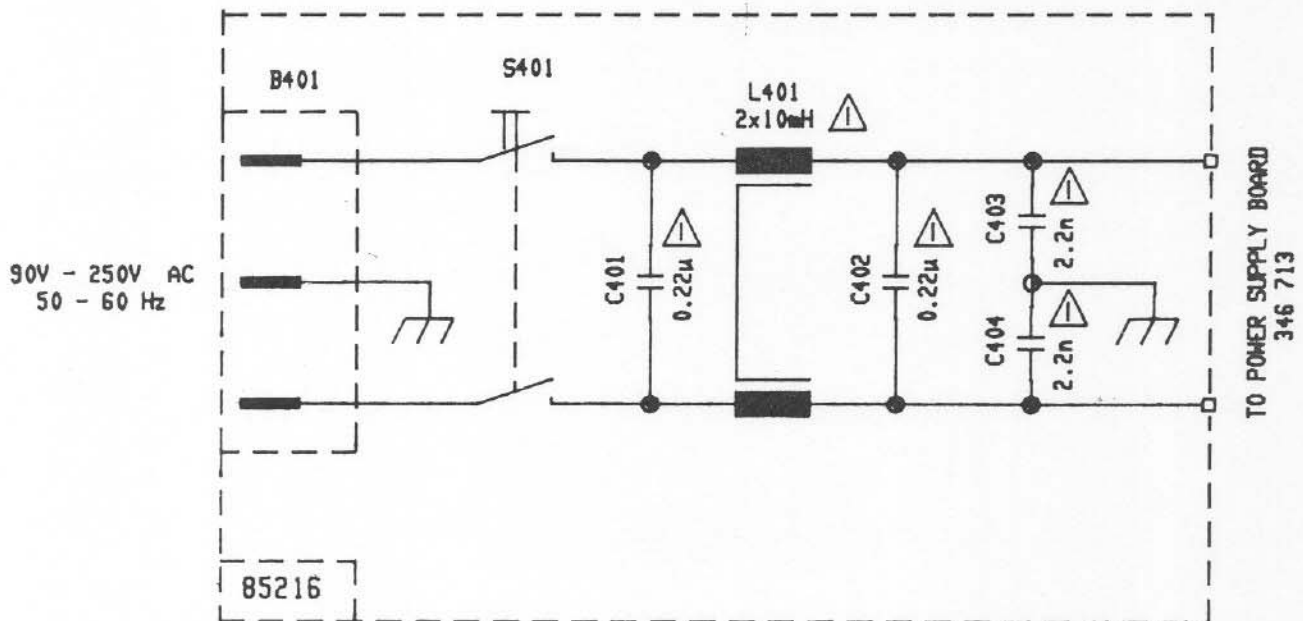

DYNACORD
SERVICE - LIST OF SPARE PARTS

DRP 10 EV

112519

Pos. in diagram	description	Part-No.	Pos. in diagram	description	Part-No.
00040	push button black 12,5x7	337059	L 303	coil	339139
00050	push button black 6,4x 13,4	342496	L 304	coil	339139
00060	rotary knob black 24	337057	L 305	coil	339139
00070	rotary knob black 16	342120	L 306	coil	339139
00080	power supply	346713	L 307	coil	339139
00110	push button grey	344280	L 308	coil	339139
00120	display	344928	L 309	coil	339139
			Q 201	trans. BC 560 B	306928
00010	PCB DRP 10	803818	Q 202	trans. BC 550 B	301184
B 201	socket	303093	Q 203	trans. BC 550 B	301184
B 202	socket	303093	Q 301	trans. BC 550 B	301184
B 203	socket	303093	R 302	trim. pot. 100k lin	338893
B 204	phone jack	332352	S 201	sliding switch	338886
B 205	phone jack HLJ	332353	S 301	switch	344038
B 206	phone jack	332352	S 302	switch	344037
B 301	phone jack	332352	U 201	IC SAB 80535 N	341631
B 302	phone jack	332352	U 202	IC SN 74 HC573 N	341636
B 303	phone jack	332352	U 204	IC CXK 58256 P-12L	339671
B 304	phone jack	332352	U 205	IC SN 74 HC245 N	338389
BT201	battery	341655	U 206	IC MC 74 HC138 N	339705
C 201	safety component	343489	U 207	IC MC 74 HC 32 N	331929
C 204	KO-EL 220 MF 25V	343533	U 208	IC MC 74 HC 00 N	331920
C 301	safety component	343489	U 209	IC PC 900	333739
C 361	KO-EL 1 MF 50V	340520	U 210	IC TL 7705	335857
C 362	KO-EL 1 MF 50V	340520	U 211	IC MC 74 HC 14	333458
C 385	KO-EL 220 MF 25V	343533	U 212	IC MC 74 HC 14	333458
D 201	diode 1N 4148	301254	U 213	IC TL 072 CP	331340
D 202	diode 1N 4148	301254	U 301	IC MB 635213	344923
D 203	diode 1N 4148	301254	U 302	IC CXK 58257	344927
D 204	diode 1N 4148	301254	U 303	IC CXK 58257	344927
D 205	diode 1N 4148	301254	U 304	IC CXK 58257	344927
D 206	diode 1N 4148	301254	U 305	IC CXK 58257	344927
D 207	diode 1N 4148	301254	U 306	IC CXK 58257	344927
D 208	diode 1N 4148	301254	U 307	IC CXK 58257	344927
D 209	diode 1N 4148	301254	U 308	IC PCM 54 HP	339670
D 210	diode 1N 4148	301254	U 309	IC MC 14053 BCP	335501
D 211	diode 1N 4148	301254	U 310	IC LM 311	330767
D 212	diode 1N 4148	301254	U 311	IC TL 072 CP	331340
D 213	break down diode ZPD 3V3	301275	U 312	IC RC 4558 P	304275
D 301	diode 1N 4148	301254	U 313	IC RC 4558 P	304275
D 302	diode 1N 4148	301254	U 314	IC HAF 0019	339673
D 303	break down diode ZPD 3V3	301275	U 315	IC RC 4558 P	304275
D 304	diode 1N 4148	301254	U 316	IC TL 072 CP	331340
E 301	relay V23042-A2003-B201	339682	U 317	IC TL 072 CP	331340
L 201	coil	339139	U 318	IC HAF 0019	339673
L 202	coil	339139	U 319	IC HAF 0019	339673
L 203	coil	339139	U 320	IC RC 4558 P	304275
L 204	coil	339139	U 321	IC RC 4558 P	304275
L 205	coil	339139	U 322	IC LC 7537 N	344867
L 206	coil	339139	U 323	IC TL 072 CP	331340
L 207	coil	339139	U 324	IC TL 072 CP	331340
L 301	coil 47 UH/5,5A	333717	U 325	IC RC 4558 P	304275

Pos. in diagram description	Part-No.	Pos. in diagram description	Part-No.
U 327 IC MC 79 L 05 ACP	309721		
U 328 IC MC 74 HC 74 N	339704		
U 329 IC MC 74 HC 00 N	331920		
U 330 IC MC 78 L 05 ACP	346343		
X 201 quarz 12.0000MHZ	346314		
X 301 quarz 45.0000MHZ	346313		
00010 socket 6pol.	339842		
00020 PCB DRP10/DRP 15	852168		
B 401 connector	338835		
C 401 safety component 0,22MF	344934		
C 402 safety component 0,22MF	344934		
C 403 safety component 2.2NF	334682		
C 404 safety component 2.2NF	334682		
L 401 coil 2x 10 MH	332961		
00030 PCB DRP 10	861908		
D 101 LED red	345450		
D 102 LED red	345450		
D 103 LED red	345450		
D 104 LED red	345450		
D 105 LED red	345450		
D 106 LED red	345450		
D 107 LED red	345450		
D 108 LED red	345450		
D 109 LED red	345450		
D 110 LED red	345450		
D 111 LED red	345450		
D 112 LED red	345450		
D 113 LED 7xgn+3xrt	344868		
DP101 display TDSR 3160	331390		
DP102 display TDSR 3160	331390		
R 104 potentiometer 2x5kohm log	345484		
S 101 switch	339674		
S 102 switch	339674		
S 103 switch	339674		
S 104 switch	339674		
S 105 switch	339674		
S 106 switch	339674		
S 107 switch	339674		
S 108 switch	339674		
S 109 switch	339674		
S 110 switch	339674		
S 111 switch	339674		
S 112 switch	339674		
S 113 switch	339674		
S 114 switch	339674		
S 115 switch	339674		
U 101 IC UAA 2022 P	333487		
U 102 IC MC 14489 P	344866		

WIRING DIAGRAM

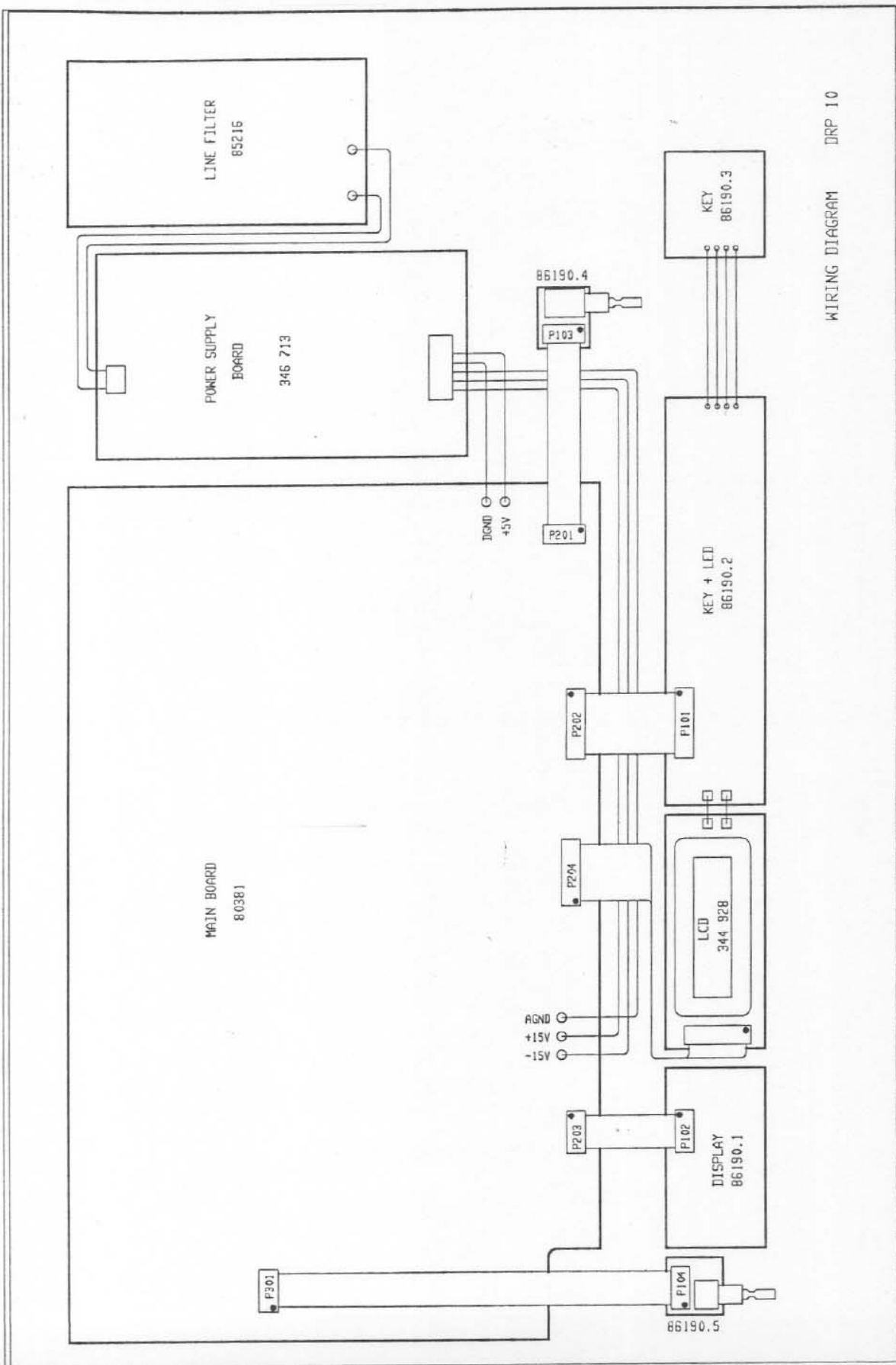

WIRING DIAGRAM DRP 10

ABMESSUNGEN / DIMENSIONS (in mm)

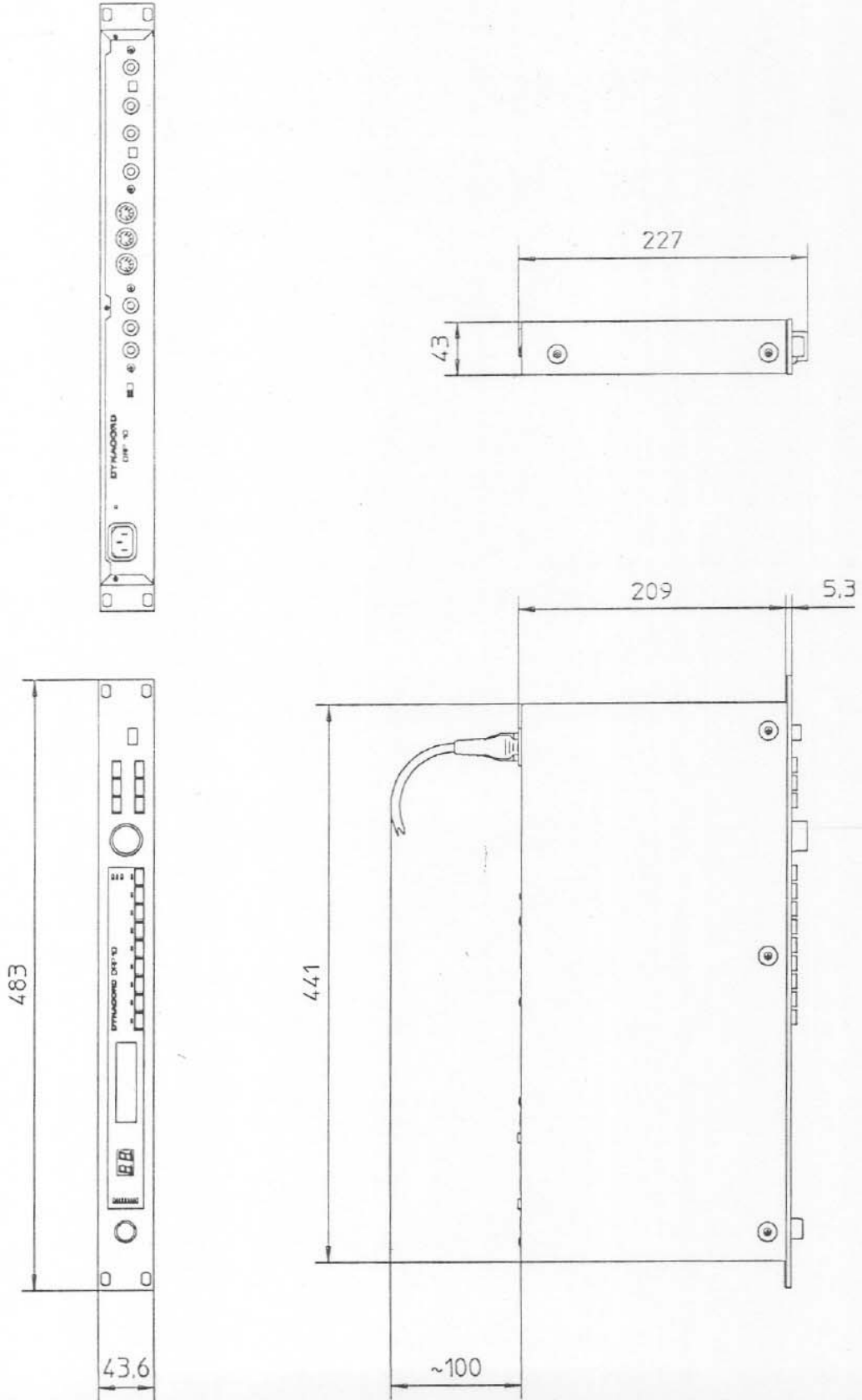

WARRANTY (Limited)

Electro-Voice products are guaranteed against malfunction due to defects in materials or workmanship for a specified period, as noted in the individual product-line statement(s) below, or in the individual product data sheet or owner's manual, beginning with the date of original purchase. If such malfunction occurs during the specified period, the product will be repaired or replaced (at our option) without charge. The product will be returned to the customer prepaid. **Exclusions and Limitations:** The Limited Warranty does not apply to: (a) exterior finish or appearance; (b) certain specific items described in the individual product-line statement(s) below, or in the individual product data sheet or owner's manual; (c) malfunction resulting from use or operation of the product other than as specified in the product data sheet or owner's manual; (d) malfunction resulting from misuse or abuse of the product; or (e) malfunction occurring at any time after repairs have been made to the product by anyone other than Electro-Voice or any of its authorized service representatives. **Obtaining Warranty Service:** To obtain warranty service, a customer must deliver the product, prepaid, to Electro-Voice or any of its authorized service representatives together with proof of purchase of the product in the form of a bill of sale or receipted invoice. A list of authorized service representatives is available from Electro-Voice at 600 Cecil Street, Buchanan, MI 49107 (616/695-6831) and/or Electro-Voice West, at 8294 Doe Avenue, Visalia, CA 93291 (209/651-7777). **Incidental and Consequential Damages Excluded:** Product repair or replacement and return to the customer are the only remedies provided to the customer. Electro-Voice shall not be liable for any incidental or consequential damages including, without limitation, injury to persons or property or loss of use. Some states do not allow the exclusion or limitation of incidental or consequential damages so the above limitation or exclusion may not apply to you. **Other Rights:** This warranty gives you specific legal rights, and you may also have other rights which vary from state to state.

Electro-Voice Electronics are guaranteed against malfunction due to defects in materials or workmanship for a period of three (3) years from the date of original purchase. Additional details are included in the Uniform Limited Warranty statement.

Service and repair address for this product: Electro-Voice, Inc. 600 Cecil Street, Buchanan, Michigan 49107.

Specifications subject to change without notice.



Electro-Voice a MARK IV company

600 Cecil Street, Buchanan, Michigan 49107, Phone (616) 695-6831, Fax: 616-695-1304

8234 Doe Avenue, Visalia, California 93291, Phone (209) 651-7777, Fax: (209) 651-0164

Mark IV Audio Canada, Inc. 345 Herbert St., Gananoque, Ontario, Canada K7G 2V1, Phone (613)382-2141, Fax (613)382-7466

SECTION 8.0
8.0 WIRING DIAGRAM

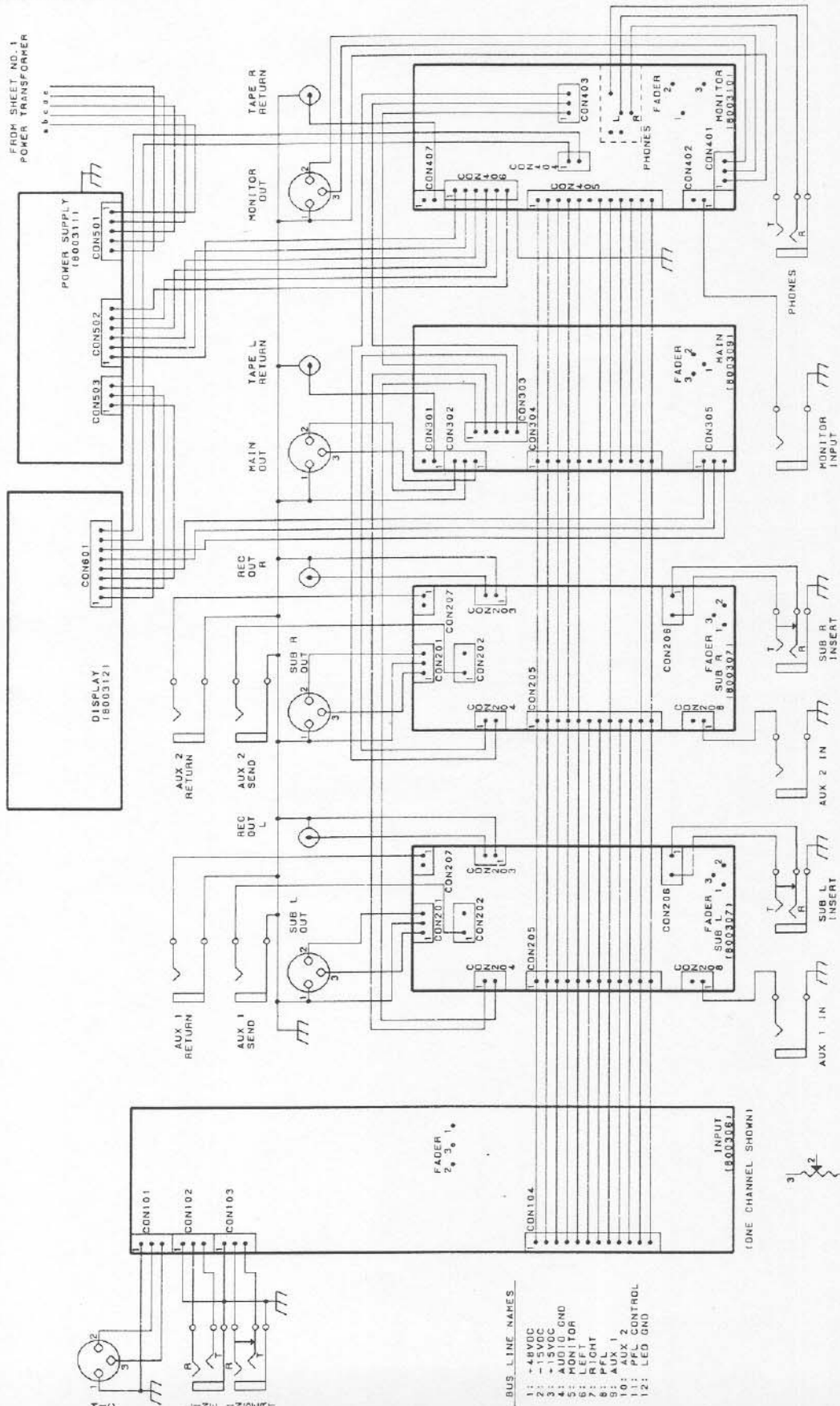

- BUS LINE NAMES
- 1: +48VDC
 - 2: -15VDC
 - 3: AUDIO GND
 - 4: AUDIO GND
 - 5: MONITOR
 - 6: LEFT
 - 7: RIGHT
 - 8: PFL
 - 9: PFL
 - 10: AUX 2
 - 11: PFL CONTROL
 - 12: LED GND

(ONE CHANNEL SHOWN)

FADER (TYP.)

SECTION 9.0
9.0 SCHEMATIC

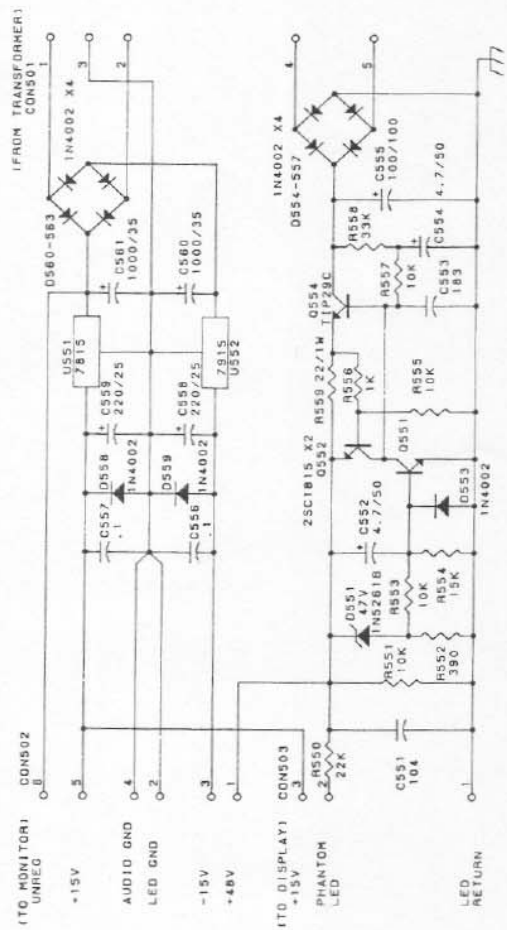

POWER SUPPLY BOARD

SERVICE INFORMATION

1. RESISTANCE VALUES ARE INDICATED IN OHMS UNLESS OTHERWISE SPECIFIED.
(K=1,000 M=1,000,000)
2. CAPACITANCE VALUES ARE SHOWN IN MICROFARADS UNLESS OTHERWISE NOTED.
(P=PICTORAD)
3. RESISTORS ARE 5% CARBON FILM .25W UNLESS OTHERWISE SPECIFIED.
(* DENOTES 1% METAL FILM .25W*11)

SECTION 9.0
9.0 SCHEMATIC

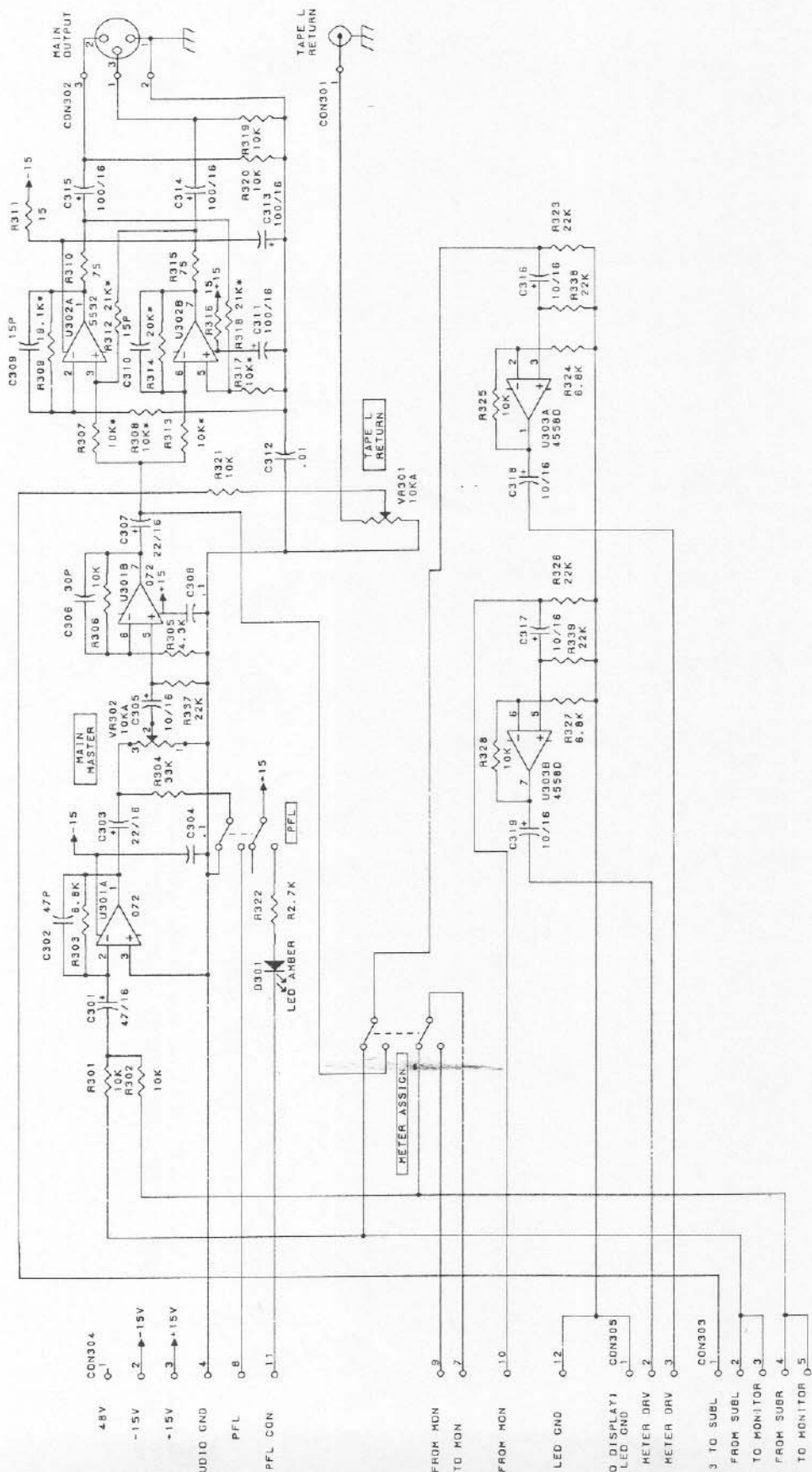

MAIN BOARD

SECTION 9.0
9.0 SCHEMATIC

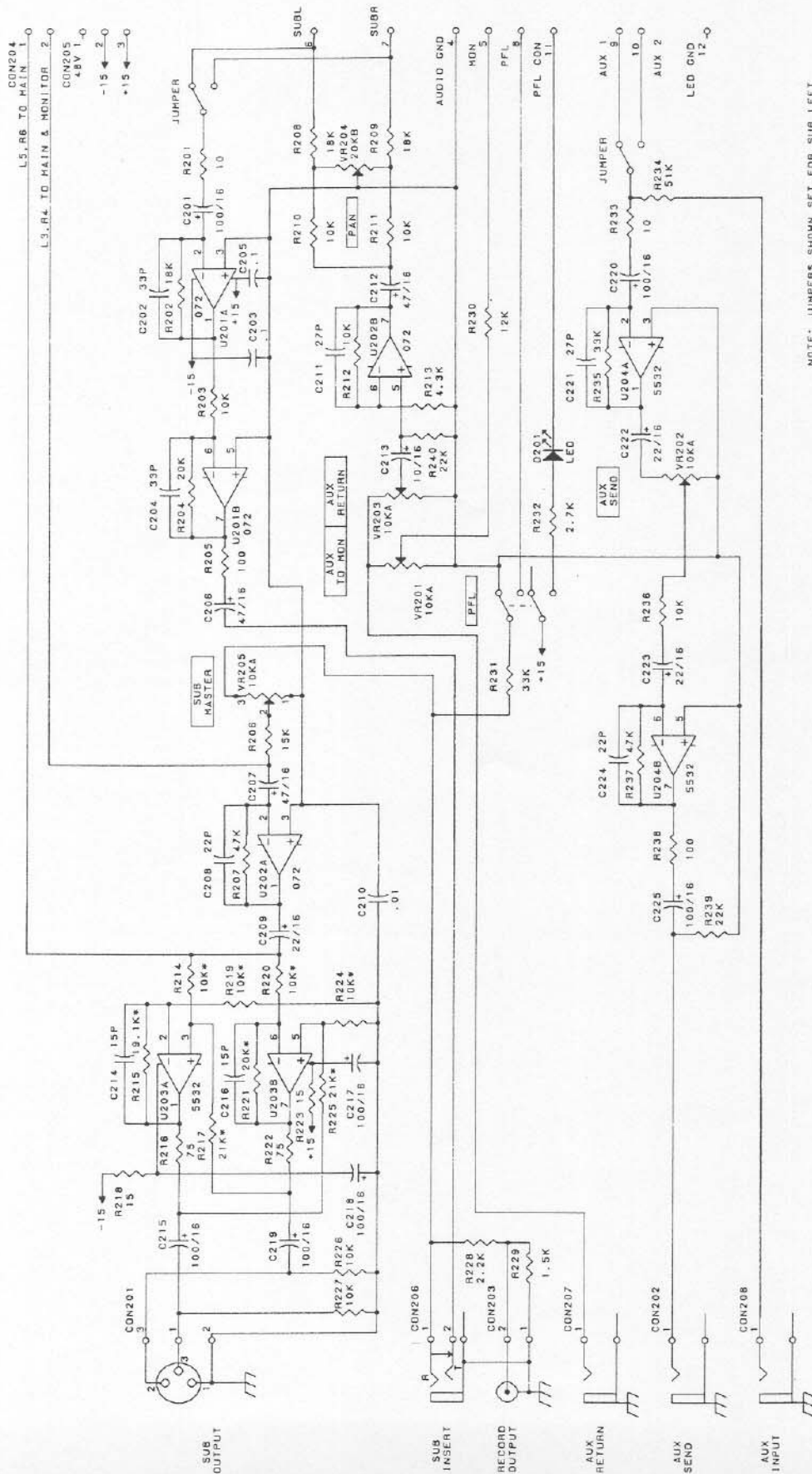

NOTE: JUMPERS SHOWN SET FOR SUB LEFT

SUB BOARD

SECTION 9.0
9.0 SCHEMATIC

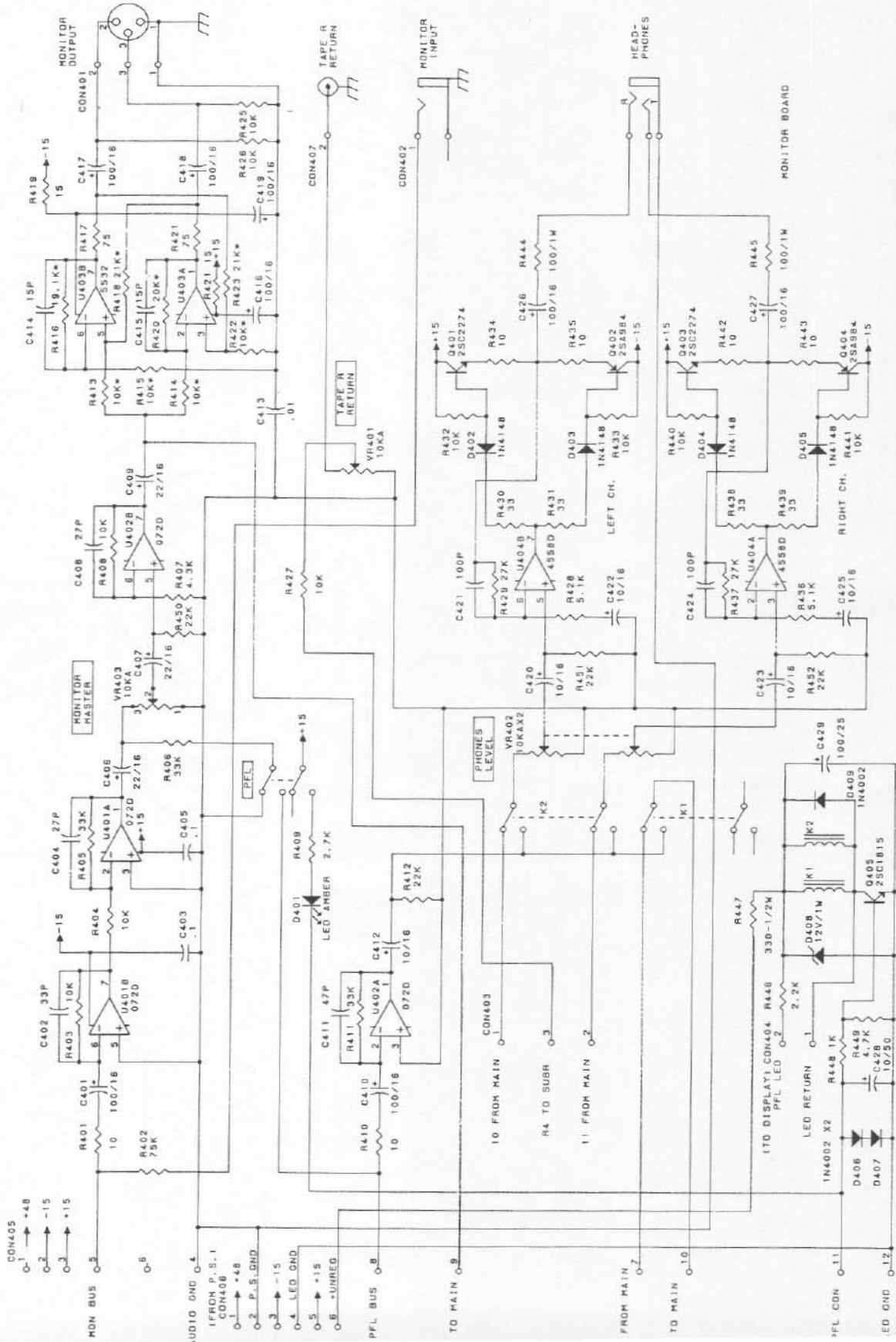

SECTION 9.0
9.0 SCHEMATIC

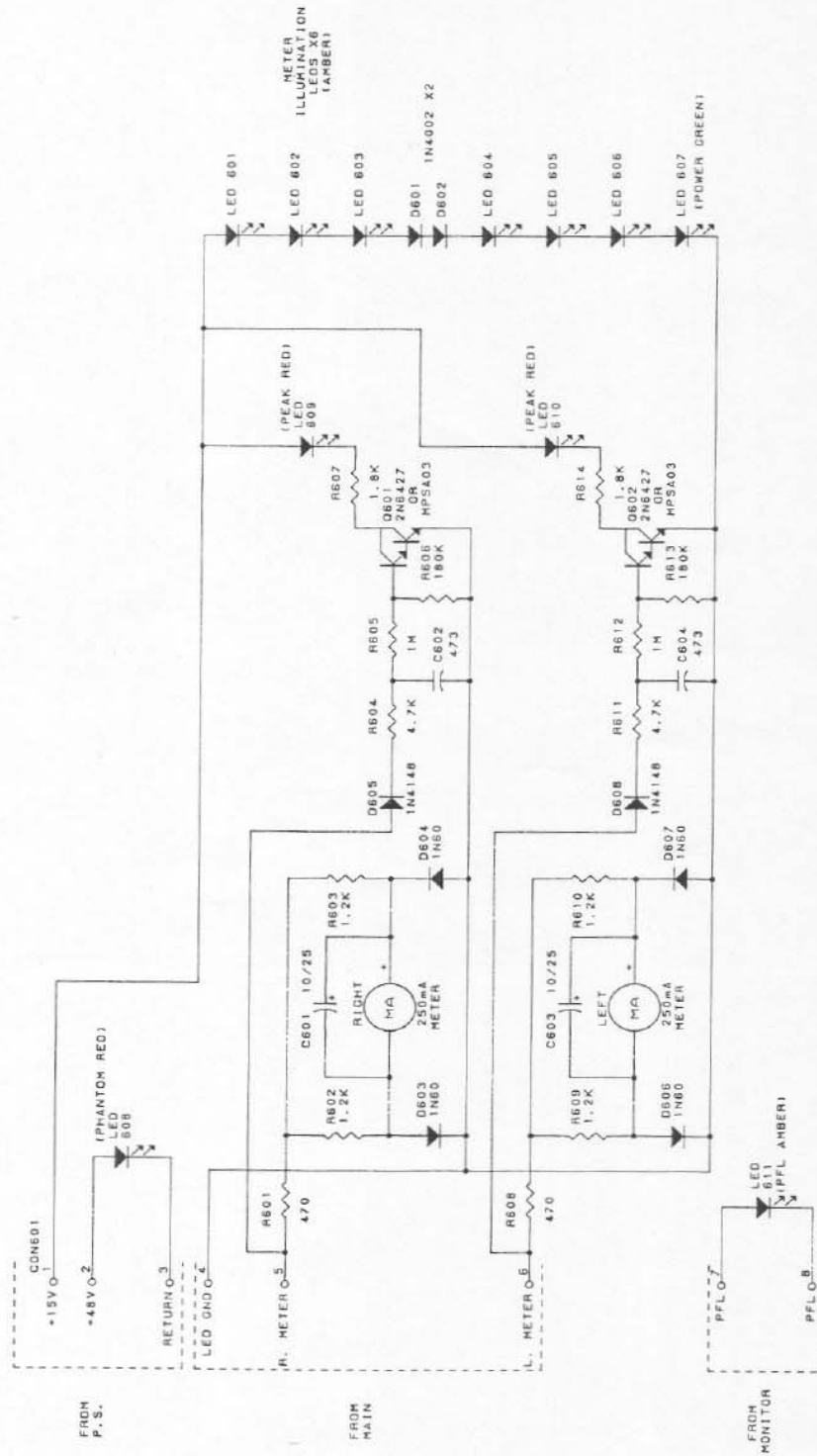

DISPLAY BOARD

SECTION 9.0
9.0 SCHEMATIC

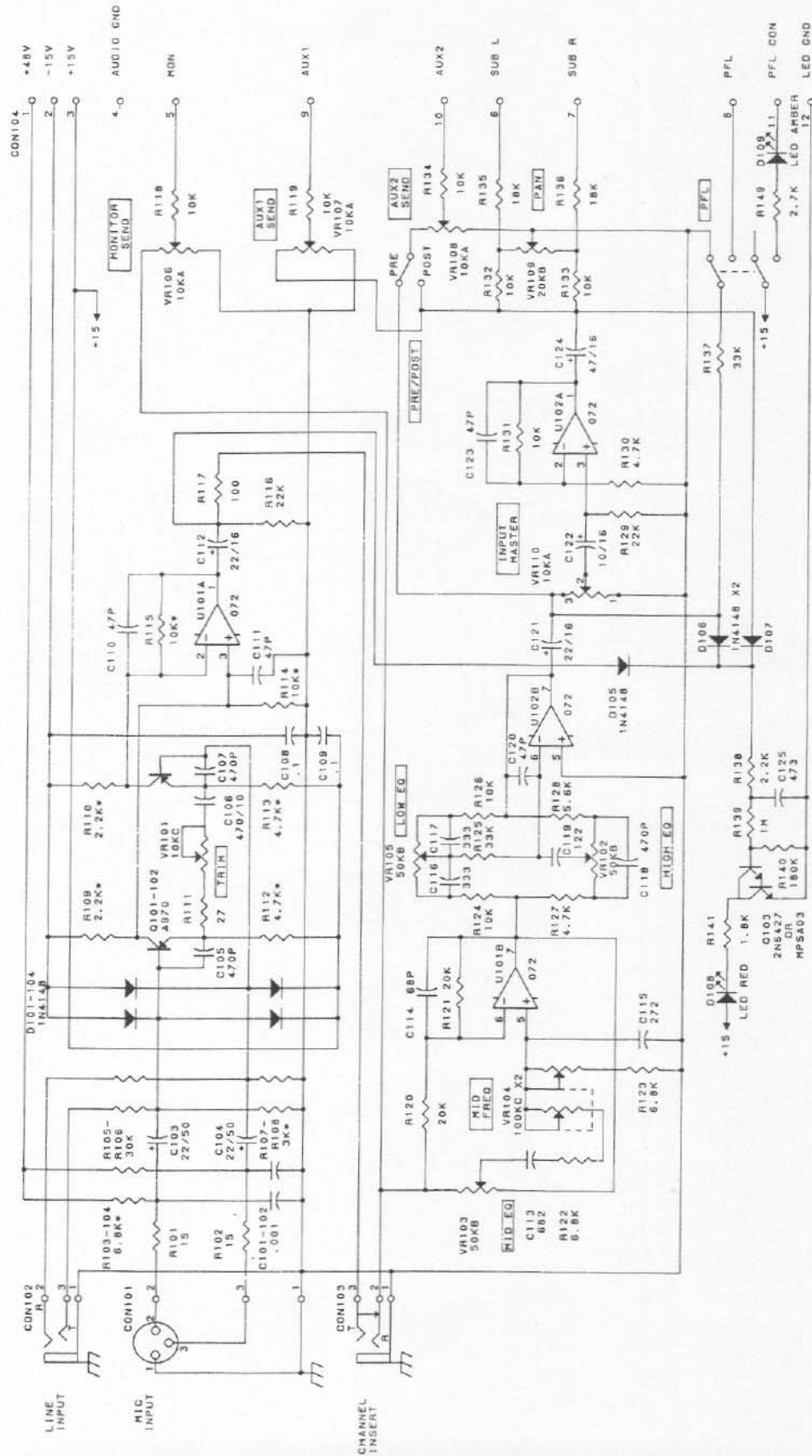

INPUT BOARD

A3 POWER SUPPLY CONTROL

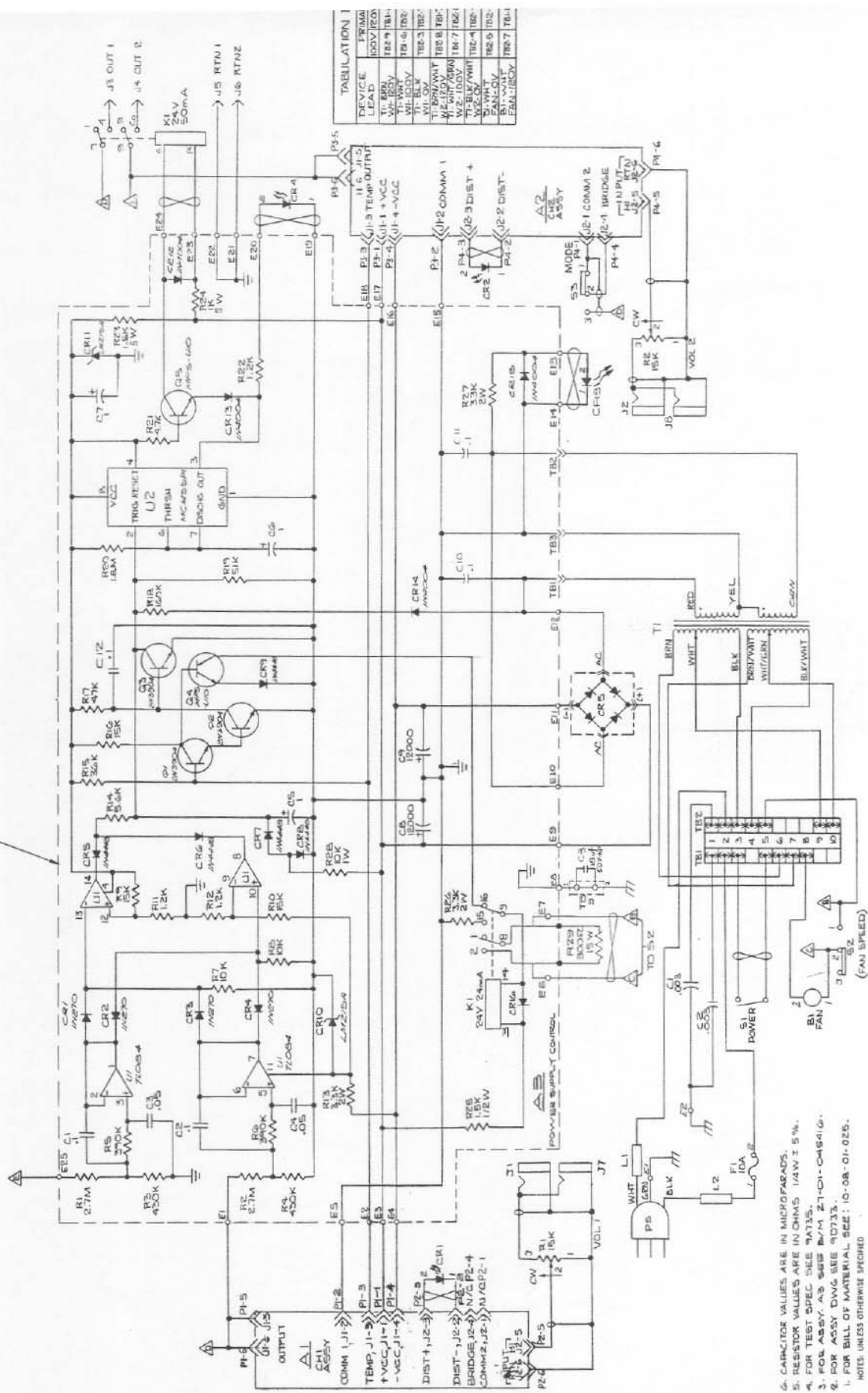

TABULATION 1

REF/PCB	TERMINAL
W1-1	WHT
W1-2	BLK
W1-3	WHT/BLN
W1-4	BLK/WHT
W1-5	WHT
W1-6	BLK
W1-7	WHT/BLN
W1-8	BLK/WHT
W1-9	WHT
W1-10	BLK
W1-11	WHT/BLN
W1-12	BLK/WHT
W1-13	WHT
W1-14	BLK
W1-15	WHT/BLN
W1-16	BLK/WHT
W1-17	WHT
W1-18	BLK
W1-19	WHT/BLN
W1-20	BLK/WHT
W1-21	WHT
W1-22	BLK
W1-23	WHT/BLN
W1-24	BLK/WHT
W1-25	WHT
W1-26	BLK
W1-27	WHT/BLN
W1-28	BLK/WHT
W1-29	WHT
W1-30	BLK
W1-31	WHT/BLN
W1-32	BLK/WHT
W1-33	WHT
W1-34	BLK
W1-35	WHT/BLN
W1-36	BLK/WHT
W1-37	WHT
W1-38	BLK
W1-39	WHT/BLN
W1-40	BLK/WHT
W1-41	WHT
W1-42	BLK
W1-43	WHT/BLN
W1-44	BLK/WHT
W1-45	WHT
W1-46	BLK
W1-47	WHT/BLN
W1-48	BLK/WHT
W1-49	WHT
W1-50	BLK
W1-51	WHT/BLN
W1-52	BLK/WHT
W1-53	WHT
W1-54	BLK
W1-55	WHT/BLN
W1-56	BLK/WHT
W1-57	WHT
W1-58	BLK
W1-59	WHT/BLN
W1-60	BLK/WHT
W1-61	WHT
W1-62	BLK
W1-63	WHT/BLN
W1-64	BLK/WHT
W1-65	WHT
W1-66	BLK
W1-67	WHT/BLN
W1-68	BLK/WHT
W1-69	WHT
W1-70	BLK
W1-71	WHT/BLN
W1-72	BLK/WHT
W1-73	WHT
W1-74	BLK
W1-75	WHT/BLN
W1-76	BLK/WHT
W1-77	WHT
W1-78	BLK
W1-79	WHT/BLN
W1-80	BLK/WHT
W1-81	WHT
W1-82	BLK
W1-83	WHT/BLN
W1-84	BLK/WHT
W1-85	WHT
W1-86	BLK
W1-87	WHT/BLN
W1-88	BLK/WHT
W1-89	WHT
W1-90	BLK
W1-91	WHT/BLN
W1-92	BLK/WHT
W1-93	WHT
W1-94	BLK
W1-95	WHT/BLN
W1-96	BLK/WHT
W1-97	WHT
W1-98	BLK
W1-99	WHT/BLN
W1-100	BLK/WHT

6. CAPACITOR VALUES ARE IN MICROFARADS.
 5. RESISTOR VALUES ARE IN OHMS 1/4W ± 5%.
 4. FOR TEST SPEC SEE 74735.
 3. FOR ASSY A3 SEE B/M 27-01-045416.
 2. FOR ASSY DWG SEE 90733.
 1. FOR BILL OF MATERIAL SEE: 10-08-01-026.
- NOTES UNLESS OTHERWISE SPECIFIED

Figure 3. Schematic (9D732-03), Power Supply/Control